

The RF MOSFET Line

RF Power Field-Effect Transistor

N-Channel Enhancement-Mode MOSFET

MRF171A

**45 W, 150 MHz
MOSFET BROADBAND
RF POWER FET**

Designed primarily for wideband large-signal output and driver stages from 30–200 MHz.

- Guaranteed Performance at 150 MHz, 28 Vdc
Output Power = 45 Watts
Power Gain = 17 dB (Min)
Efficiency = 60% (Min)
- Excellent Thermal Stability, Ideally Suited for Class A Operation
- Facilitates Manual Gain Control, ALC and Modulation Techniques
- 100% Tested for Load Mismatch At All Phase Angles with 30:1 VSWR
- Low Crss – 8 pF @ V_{DS} = 28 V
- Gold Top Metal

Typical Data For Power Amplifier Applications in Industrial, Commercial and Amateur Radio Equipment

- Typical Performance at 30 MHz, 28 Vdc
Output Power = 30 Watts (PEP)
Power Gain = 20 dB (Typ)
Efficiency = 50% (Typ)
IMD(d3) (30 Watts PEP) –32 dB (Typ)
- S-Parameters Available for Download into Frequency Domain Simulators.
See <http://motorola.com/sps/rf/designtds/>

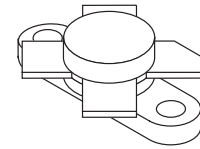
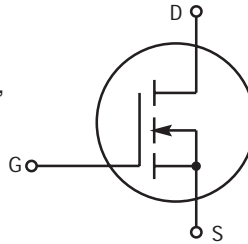

CASE 211-07, STYLE 2

MAXIMUM RATINGS

Rating	Symbol	Value	Unit
Drain–Gate Voltage	V _{DSS}	65	Vdc
Drain–Gate Voltage (R _{GS} = 1.0 MΩ)	V _{DGR}	65	Vdc
Gate–Source Voltage	V _{GS}	±20	Adc
Drain Current — Continuous	I _D	4.5	Adc
Total Device Dissipation @ T _C = 25°C Derate above 25°C	P _D	115 0.66	Watts W/°C
Storage Temperature Range	T _{stg}	–65 to +150	°C
Operating Junction Temperature	T _J	200	°C

THERMAL CHARACTERISTICS

Characteristic	Symbol	Max	Unit
Thermal Resistance, Junction to Case	R _{θJC}	1.52	°C/W

ELECTRICAL CHARACTERISTICS (T_C = 25°C unless otherwise noted)

Characteristic	Symbol	Min	Typ	Max	Unit
----------------	--------	-----	-----	-----	------

OFF CHARACTERISTICS

Drain–Source Breakdown Voltage (I _D = 50 mA, V _{GS} = 0)	V _{(BR)DSS}	65	80	—	Vdc
Zero Gate Voltage Drain Current (V _{GS} = 0, V _{DS} = 28 V)	I _{DSS}	—	—	1.0	mA
Gate–Source Leakage Current (V _{GS} = 20 V, V _{DS} = 0)	I _{GSS}	—	—	1.0	μA

NOTE – CAUTION – MOS devices are susceptible to damage from electrostatic charge. Reasonable precautions in handling and packaging MOS devices should be observed.

ELECTRICAL CHARACTERISTICS – continued ($T_C = 25^\circ\text{C}$ unless otherwise noted)

Characteristic	Symbol	Min	Typ	Max	Unit
----------------	--------	-----	-----	-----	------

ON CHARACTERISTICS

Gate Threshold Voltage ($V_{DS} = 10\text{ V}$, $I_D = 50\text{ mA}$)	$V_{GS(th)}$	1.5	2.5	4.5	Vdc
Drain–Source On–Voltage ($V_{GS} = 10\text{ V}$, $I_D = 3\text{ A}$)	$V_{DS(on)}$	—	1.0	—	V
Forward Transconductance ($V_{DS} = 10\text{ V}$, $I_D = 2\text{ A}$)	g_{fs}	1.4	1.8	—	mhos

DYNAMIC CHARACTERISTICS

Input Capacitance ($V_{DS} = 28\text{ V}$, $V_{GS} = 0$, $f = 1.0\text{ MHz}$)	C_{iss}	—	60	—	pF
Output Capacitance ($V_{DS} = 28\text{ V}$, $V_{GS} = 0$, $f = 1.0\text{ MHz}$)	C_{oss}	—	70	—	pF
Reverse Transfer Capacitance ($V_{DS} = 28\text{ V}$, $V_{GS} = 0$, $f = 1.0\text{ MHz}$)	C_{rss}	—	8	—	pF

FUNCTIONAL CHARACTERISTICS

Common Source Power Gain ($V_{DD} = 28\text{ V}$, $P_{out} = 45\text{ W}$, $f = 150\text{ MHz}$, $I_{DQ} = 25\text{ mA}$)	G_{ps}	17	19.5	—	dB
Drain Efficiency ($V_{DD} = 28\text{ V}$, $P_{out} = 45\text{ W}$, $f = 150\text{ MHz}$, $I_{DQ} = 25\text{ mA}$)	η	60	70	—	%
Electrical Ruggedness ($V_{DD} = 28\text{ V}$, $P_{out} = 45\text{ W}$, $f = 150\text{ MHz}$, $I_{DQ} = 25\text{ mA}$, VSWR 30:1 at All Phase Angles)		No Degradation in Output Power			

TYPICAL FUNCTIONAL TESTS (SSB)

Common Source Power Gain ($V_{DD} = 28\text{ V}$, $P_{out} = 30\text{ W}$ (PEP), $I_{DQ} = 100\text{ mA}$, $f = 30$; 30.001 MHz)	G_{ps}	—	20	—	dB
Drain Efficiency ($V_{DD} = 28\text{ V}$, $P_{out} = 30\text{ W}$ (PEP), $I_{DQ} = 100\text{ mA}$, $f = 30$; 30.001 MHz)	η	—	50	—	%
Intermodulation Distortion ($V_{DD} = 28\text{ V}$, $P_{out} = 30\text{ W}$ (PEP), $I_{DQ} = 100\text{ mA}$, $f = 30$; 30.001 MHz)	IMD(d3)	—	–32	—	dB

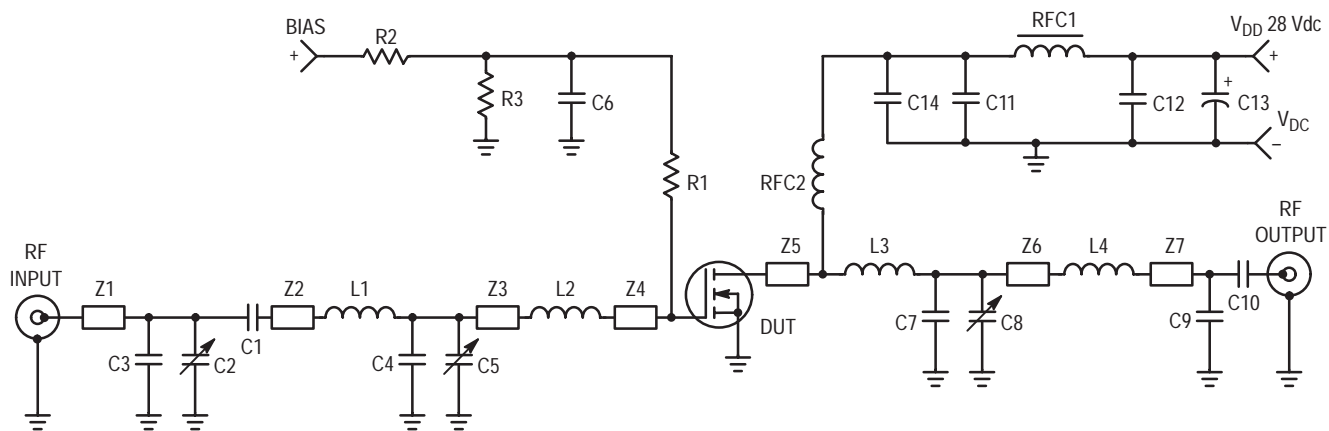

C1, C10	1000 pF, Chip Capacitor	R2	1 k Ω , 1/2 W Chip Resistor
C2, C5, C8	2–20 pF, Trimmer Capacitors, Johanson	R3	10 k Ω , 1/2 W Chip Resistor
C3	43 pF, 100 mil Chip Capacitor, ATC	Z1	0.160" x 0.400" Microstrip
C4	120 pF, 100 mil Chip Capacitor, ATC	Z2	0.160" x 0.600" Microstrip
C6, C14	0.1 μ F, Capacitors	Z3	0.160" x 0.600" Microstrip
C7	50 pF, 100 mil Chip Capacitor, ATC	Z4	0.160" x 0.900" Microstrip
C9	12 pF, 100 mil Chip Capacitor, ATC	Z5	0.160" x 0.800" Microstrip
C11, C12	680 pF, Feedthru Capacitors	Z6	0.160" x 0.800" Microstrip
C13	50 μ F, 50 V, Electrolytic Capacitor	Z7	0.160" x 0.400" Microstrip
L1	2 Turns, 0.297" ID, 18 AWG	RFC1	Ferroxcube VK200–19/4B
L2	1–1/2 Turns, 0.265" ID, 18 AWG	RFC2	10 Turns, 0.250" ID, 20 AWG, Enamel
L3	1–1/4 Turns, 0.234" ID, 18 AWG	Board	0.062", G10 1 oz. Copper Clad
L4	1–1/2 Turns, 0.250" ID, 18 AWG		Both Sides, $\epsilon_r = 2.56$
R1	68 Ω , 1/2 W Chip Resistor		

Figure 1. MRF171A 150 MHz Test Circuit

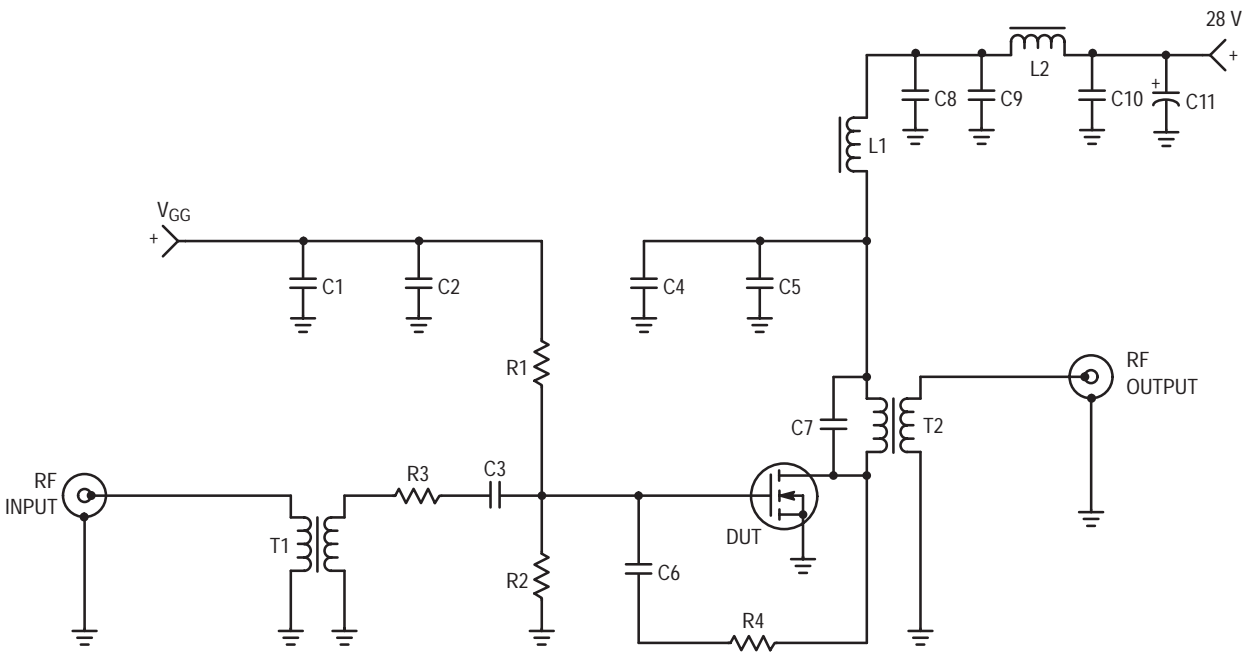

C1, C3, C5, C6	0.1 μ F, Chip Capacitors	L1, L2	VK200 20/4B Ferrite Choke
C2, C4	1000 pF, Chip Capacitors	R1, R2	200 Ω , 1/2 W Carbon
C7	68 pF, Dipped Mica	R3	3 Ω , 1/2 W Carbon
C8	0.1 μ F, Ceramic Cap or Equivalent	R4	270 Ω , 2 W Carbon
C9, C10	680 pF, Feedthru Capacitors	T1	4:1 Impedance Broadband Transformer
C11	250 μ F, 50 V, Electrolytic Capacitor	T2	1:4 Impedance Broadband Transformer

Figure 2. MRF171A 30 MHz Test Circuit

TYPICAL CHARACTERISTICS

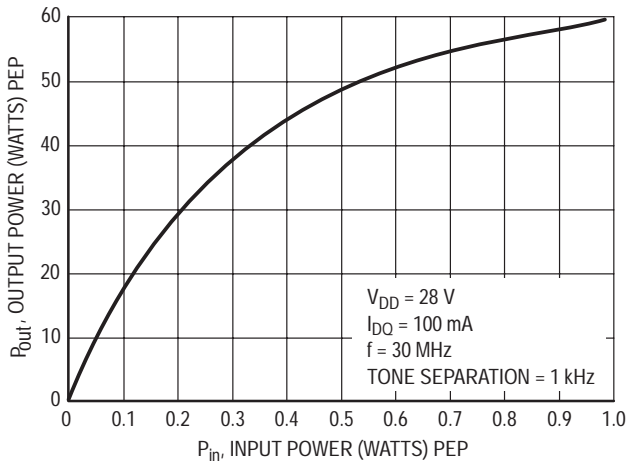

Figure 3. Output Power versus Input Power

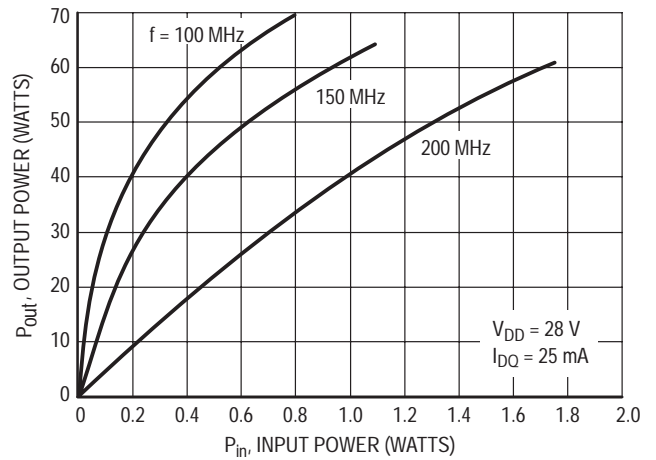

Figure 4. Output Power versus Input Power

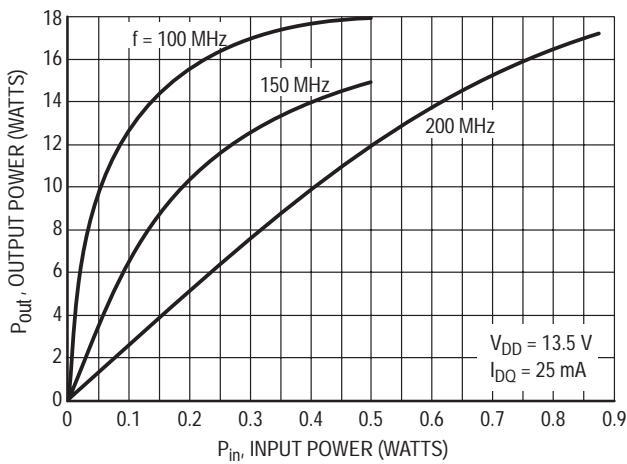

Figure 5. Output Power versus Input Power

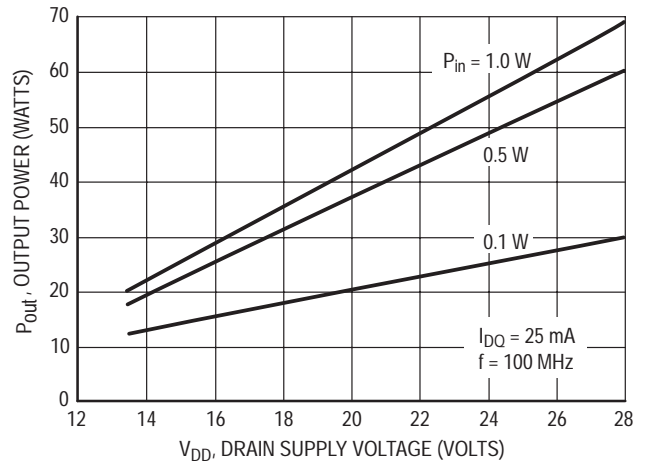

Figure 6. Output Power versus Supply Voltage

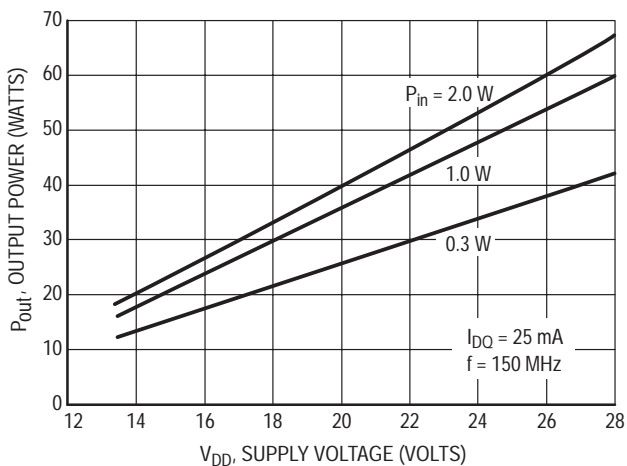

Figure 7. Output Power versus Supply Voltage

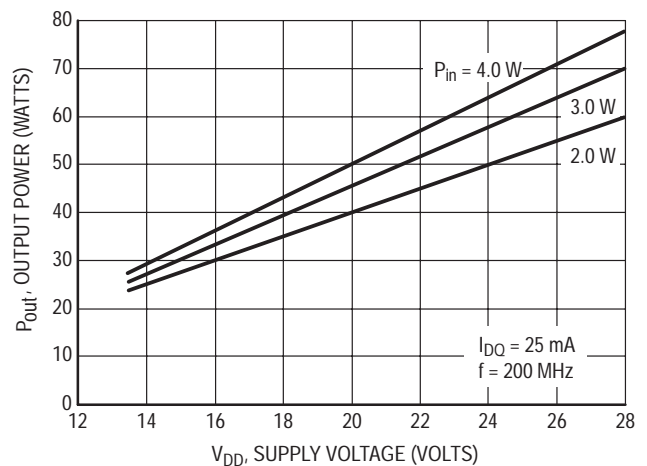

Figure 8. Output Power versus Supply Voltage

TYPICAL CHARACTERISTICS

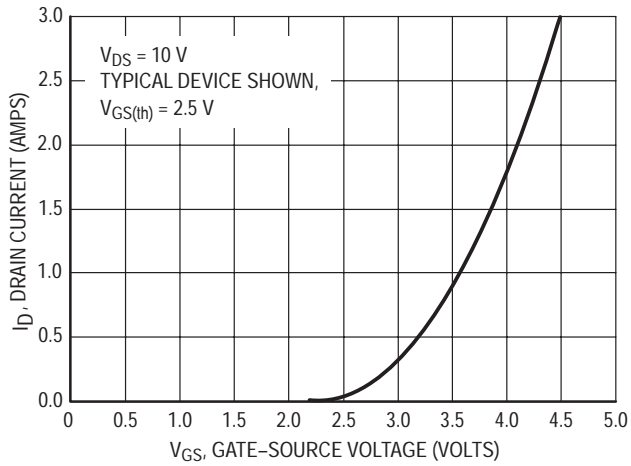

Figure 9. Drain Current versus Gate Voltage (Transfer Characteristics)

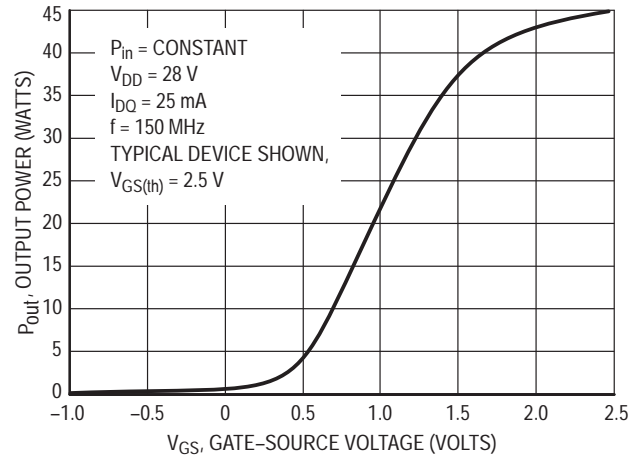

Figure 10. Output Power versus Gate Voltage

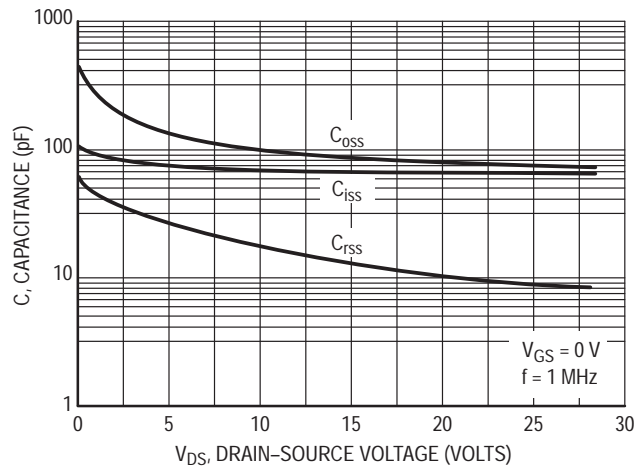
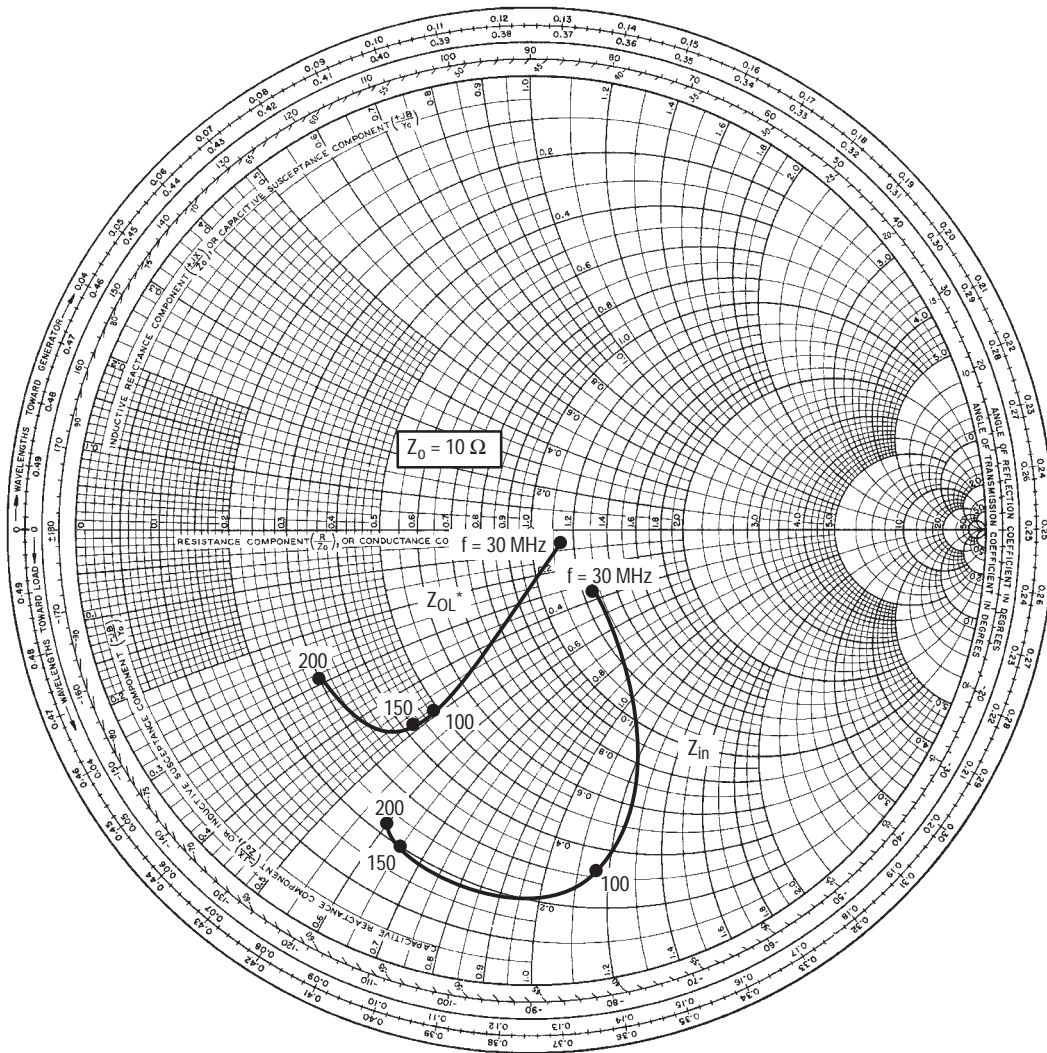

Figure 11. Capacitance versus Drain-Source Voltage



$V_{DD} = 28 \text{ V}$, $I_{DQ} = 25 \text{ mA}$, $P_{out} = 45 \text{ W}$

f MHz	$Z_{in}(1)$ Ω	$Z_{OL}(2)$ Ω
30	$12.8 - j3.6$	$11.5 - j0.99$
100	$3.1 - j11.6$	$4.9 - j4.9$
150	$2.0 - j6.5$	$4.2 - j4.9$
200	$2.2 - j6.0$	$3.0 - j2.9$

(1) 68Ω shunt resistor gate-to-ground.

(2) Z_{OL} = Conjugate of the optimum load impedance into which the device operates at a given output power, voltage and frequency.

Figure 12. Large-Signal Series Equivalent Input/Output Impedance

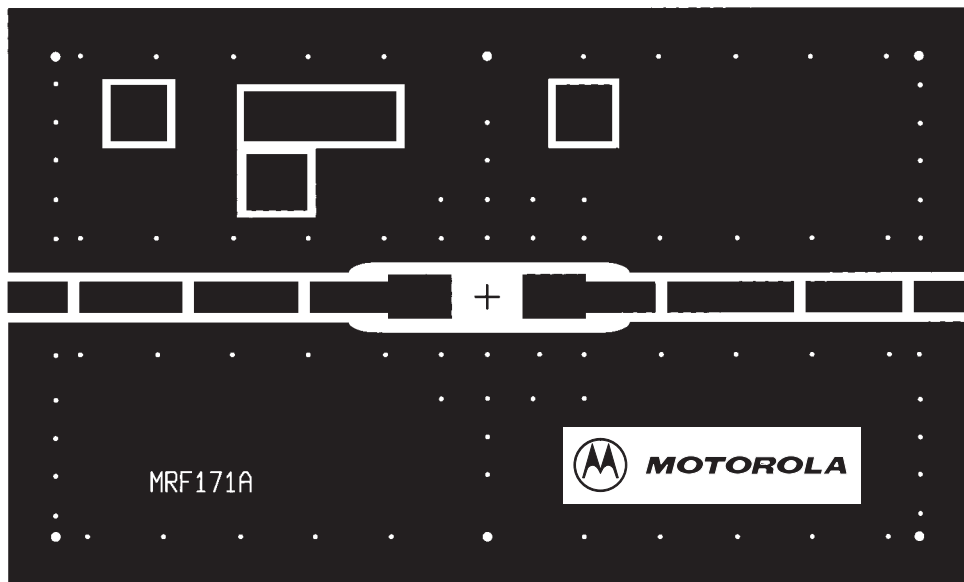

(Scale 1:1)

**Figure 13. MRF171A Circuit Board Photo Master
(Reduced 18% in printed data book, DL110/D)**

Table 1. Common Source S-Parameters ($V_{DS} = 12.5\text{ V}$, $I_D = 0.5\text{ A}$)

f MHz	S ₁₁		S ₂₁		S ₁₂		S ₂₂	
	S ₁₁	φ	S ₂₁	φ	S ₁₂	φ	S ₂₂	φ
30	0.801	-162	11.90	96	0.026	13	0.811	-166
40	0.809	-166	9.12	91	0.028	11	0.812	-171
50	0.810	-169	7.29	88	0.027	11	0.831	-172
60	0.808	-170	6.22	85	0.028	9	0.824	-174
70	0.814	-172	5.30	82	0.028	9	0.831	-176
80	0.811	-173	4.56	81	0.027	10	0.837	-175
90	0.811	-174	4.04	80	0.027	13	0.829	-174
100	0.814	-174	3.66	77	0.027	12	0.846	-176
110	0.812	-175	3.37	75	0.027	11	0.842	-177
120	0.816	-175	3.00	74	0.027	13	0.850	-176
130	0.816	-176	2.75	73	0.027	14	0.849	-175
140	0.817	-176	2.57	72	0.027	17	0.851	-176
150	0.821	-176	2.37	69	0.027	17	0.863	-177
160	0.820	-176	2.27	67	0.027	17	0.853	-177
170	0.821	-177	2.08	66	0.026	19	0.838	-177
180	0.824	-177	1.93	65	0.027	19	0.861	-177
190	0.825	-177	1.89	64	0.027	21	0.873	-177
200	0.830	-177	1.74	62	0.027	23	0.873	-178
210	0.831	-177	1.67	60	0.027	25	0.874	-177
220	0.831	-178	1.62	59	0.026	28	0.870	-178
230	0.836	-178	1.48	57	0.027	27	0.909	-179
240	0.836	-178	1.43	56	0.027	26	0.865	-180
250	0.839	-178	1.37	57	0.028	30	0.873	-178
260	0.844	-178	1.30	54	0.028	34	0.882	-179
270	0.842	-178	1.28	52	0.028	36	0.887	-180
280	0.845	-179	1.21	52	0.027	37	0.881	-180
290	0.849	-179	1.14	50	0.027	36	0.869	179
300	0.849	-179	1.12	50	0.029	39	0.852	-180
310	0.855	-179	1.06	49	0.029	42	0.891	-179
320	0.856	-179	1.03	46	0.030	43	0.889	180
330	0.856	-180	0.96	45	0.031	47	0.868	180
340	0.858	-180	0.96	46	0.030	47	0.888	179
350	0.860	180	0.93	44	0.031	49	0.875	-180
360	0.862	180	0.91	44	0.033	48	0.901	179
370	0.866	180	0.86	43	0.034	50	0.913	178
380	0.867	179	0.84	41	0.036	52	0.897	178
390	0.869	179	0.82	42	0.035	54	0.893	178
400	0.870	179	0.78	40	0.035	57	0.880	180
410	0.872	179	0.77	39	0.037	55	0.923	178
420	0.876	178	0.73	37	0.039	54	0.915	176
430	0.877	178	0.69	38	0.040	56	0.903	177
440	0.879	178	0.68	39	0.041	58	0.921	178

Table 1. Common Source S-Parameters ($V_{DS} = 12.5\text{ V}$, $I_D = 0.5\text{ A}$) continued

f MHz	S ₁₁		S ₂₁		S ₁₂		S ₂₂	
	S ₁₁	∠	S ₂₁	∠	S ₁₂	∠	S ₂₂	∠
450	0.882	177	0.68	36	0.040	61	0.926	178
460	0.884	177	0.65	36	0.041	59	0.937	175
470	0.886	177	0.62	35	0.041	60	0.896	176
480	0.885	176	0.62	33	0.044	61	0.907	176
490	0.886	176	0.61	32	0.046	63	0.907	176
500	0.887	176	0.59	31	0.047	65	0.916	175

Table 2. Common Source S-Parameters ($V_{DS} = 28\text{ V}$, $I_D = 0.5\text{ A}$)

f MHz	S ₁₁		S ₂₁		S ₁₂		S ₂₂	
	S ₁₁	∠	S ₂₁	∠	S ₁₂	∠	S ₂₂	∠
30	0.783	-152	17.10	100	0.025	17	0.730	-158
40	0.793	-158	13.20	94	0.027	13	0.730	-164
50	0.793	-162	10.50	90	0.027	12	0.754	-167
60	0.791	-165	9.00	87	0.027	11	0.746	-169
70	0.798	-167	7.68	83	0.026	10	0.760	-171
80	0.795	-169	6.63	82	0.026	10	0.770	-170
90	0.795	-170	5.85	80	0.026	12	0.760	-170
100	0.799	-170	5.30	77	0.026	10	0.779	-172
110	0.798	-171	4.86	75	0.026	11	0.775	-174
120	0.802	-172	4.35	74	0.025	13	0.785	-172
130	0.801	-172	3.97	72	0.025	14	0.788	-171
140	0.803	-173	3.70	71	0.025	15	0.791	-172
150	0.809	-173	3.42	68	0.025	14	0.808	-173
160	0.808	-173	3.27	66	0.025	15	0.796	-172
170	0.809	-174	2.99	65	0.024	18	0.783	-174
180	0.814	-174	2.77	63	0.025	19	0.809	-173
190	0.815	-175	2.71	62	0.024	21	0.820	-174
200	0.822	-175	2.49	60	0.024	22	0.826	-175
210	0.824	-175	2.37	57	0.024	24	0.836	-175
220	0.825	-175	2.23	57	0.024	26	0.807	-175
230	0.831	-176	2.08	56	0.024	29	0.839	-175
240	0.830	-176	2.00	54	0.024	29	0.818	-176
250	0.832	-176	1.92	55	0.024	33	0.828	-174
260	0.838	-176	1.81	53	0.024	35	0.829	-175
270	0.837	-176	1.79	50	0.025	37	0.834	-175
280	0.840	-177	1.69	50	0.025	39	0.832	-176
290	0.844	-177	1.60	48	0.025	39	0.836	-177
300	0.844	-177	1.55	48	0.025	44	0.814	-175
310	0.849	-178	1.48	47	0.026	46	0.848	-175
320	0.852	-178	1.43	44	0.027	45	0.855	-177
330	0.852	-178	1.35	43	0.028	48	0.833	-177
340	0.855	-178	1.32	44	0.028	49	0.861	-177
350	0.856	-178	1.29	41	0.029	53	0.842	-176

Table 2. Common Source S-Parameters ($V_{DS} = 28\text{ V}$, $I_D = 0.5\text{ A}$) continued

f MHz	S ₁₁		S ₂₁		S ₁₂		S ₂₂	
	S ₁₁	φ	S ₂₁	φ	S ₁₂	φ	S ₂₂	φ
360	0.859	-179	1.25	42	0.030	54	0.872	-178
370	0.863	-179	1.18	39	0.030	55	0.886	-178
380	0.864	-179	1.15	38	0.031	55	0.864	-178
390	0.867	-179	1.12	39	0.032	57	0.862	-179
400	0.869	-180	1.07	37	0.032	60	0.853	-177
410	0.872	-180	1.05	35	0.035	60	0.898	-179
420	0.876	180	1.00	34	0.036	60	0.889	180
430	0.877	179	0.95	35	0.037	62	0.884	-179
440	0.879	179	0.93	34	0.038	64	0.902	-179
450	0.882	179	0.91	32	0.039	65	0.901	-180
460	0.884	178	0.88	32	0.041	64	0.922	179
470	0.885	178	0.84	32	0.040	66	0.877	179
480	0.885	178	0.83	30	0.042	66	0.892	179
490	0.886	177	0.81	29	0.044	68	0.891	179
500	0.887	177	0.80	28	0.045	68	0.900	178

PACKAGE DIMENSIONS

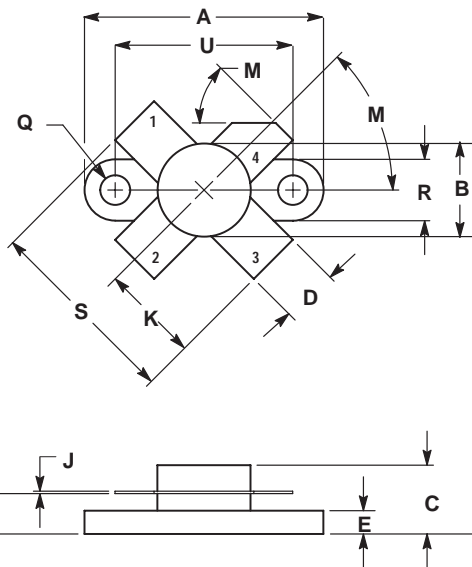

- NOTES:
 1. DIMENSIONING AND TOLERANCING PER ANSI Y14.5M, 1982.
 2. CONTROLLING DIMENSION: INCH.

DIM	INCHES		MILLIMETERS	
	MIN	MAX	MIN	MAX
A	0.960	0.990	24.39	25.14
B	0.370	0.390	9.40	9.90
C	0.229	0.281	5.82	7.13
D	0.215	0.235	5.47	5.96
E	0.085	0.105	2.16	2.66
H	0.150	0.108	3.81	4.57
J	0.004	0.006	0.11	0.15
K	0.395	0.405	10.04	10.28
M	40°	50°	40°	50°
Q	0.113	0.130	2.88	3.30
R	0.245	0.255	6.23	6.47
S	0.790	0.810	20.07	20.57
U	0.720	0.730	18.29	18.54

- STYLE 2:
 PIN 1. SOURCE
 2. GATE
 3. SOURCE
 4. DRAIN

CASE 211-07 ISSUE N

Motorola reserves the right to make changes without further notice to any products herein. Motorola makes no warranty, representation or guarantee regarding the suitability of its products for any particular purpose, nor does Motorola assume any liability arising out of the application or use of any product or circuit, and specifically disclaims any and all liability, including without limitation consequential or incidental damages. "Typical" parameters which may be provided in Motorola data sheets and/or specifications can and do vary in different applications and actual performance may vary over time. All operating parameters, including "Typicals" must be validated for each customer application by customer's technical experts. Motorola does not convey any license under its patent rights nor the rights of others. Motorola products are not designed, intended, or authorized for use as components in systems intended for surgical implant into the body, or other applications intended to support or sustain life, or for any other application in which the failure of the Motorola product could create a situation where personal injury or death may occur. Should Buyer purchase or use Motorola products for any such unintended or unauthorized application, Buyer shall indemnify and hold Motorola and its officers, employees, subsidiaries, affiliates, and distributors harmless against all claims, costs, damages, and expenses, and reasonable attorney fees arising out of, directly or indirectly, any claim of personal injury or death associated with such unintended or unauthorized use, even if such claim alleges that Motorola was negligent regarding the design or manufacture of the part. Motorola and are registered trademarks of Motorola, Inc. Motorola, Inc. is an Equal Opportunity/Affirmative Action Employer.

Mfax is a trademark of Motorola, Inc.

How to reach us:

USA/EUROPE/Locations Not Listed: Motorola Literature Distribution;
 P.O. Box 5405, Denver, Colorado 80217. 1-303-675-2140 or 1-800-441-2447

JAPAN: Motorola Japan Ltd.; SPD, Strategic Planning Office, 141,
 4-32-1 Nishi-Gotanda, Shinagawa-ku, Tokyo, Japan. 81-3-5487-8488

Customer Focus Center: 1-800-521-6274

Mfax™: RMFAX0@email.sps.mot.com – TOUCHTONE 1-602-244-6609
 Motorola Fax Back System – US & Canada ONLY 1-800-774-1848
 – http://sps.motorola.com/mfax/

ASIA/PACIFIC: Motorola Semiconductors H.K. Ltd.; Silicon Harbour Centre,
 2, Dai King Street, Tai Po Industrial Estate, Tai Po, N.T., Hong Kong.
 852-26668334

HOME PAGE: <http://motorola.com/sps/>

