

# The Fundamentals of SDH

## Overview

Recent global changes in government structures and resulting economic pressures, increased competition and growing private networks have forced telecommunications service providers throughout the world to increase their operating efficiency. Long-established analog transmission systems that proved inadequate were gradually replaced by digital communications networks. In many countries, digital transmission networks were developed based upon standards collectively known today as the *Plesiochronous Digital Hierarchy* (PDH).

Although it has numerous advantages over analog, PDH has some shortcomings: provisioning circuits can be labor-intensive and time-consuming, automation and centralized control capabilities of telecommunication networks are limited, and upgrading to emerging services can be cumbersome. A major disadvantage is that standards exist for electrical line interfaces at PDH rates, but there is no standard for optical line equipment at any PDH rate, which is specific to each manufacturer. This means that fiber optic transmission equipment from one manufacturer may not be able to interface with other manufacturers' equipment. As a result, service providers are often required to select a single vendor for deployment in areas of the network, and are locked into using the network control and monitoring capabilities of that vendor.

Reconfiguring PDH networks can be difficult and labor-intensive - resulting in costly, time-consuming modifications to the network whenever new services are introduced or when more bandwidth is required. The situation was particularly difficult in North America, where a plesiochronous system (T-Carrier) was in place. Utilizing the technological advances and associated reductions in cost since plesiochronous systems were introduced, Bellcore (the research affiliate of the Bell operating companies in the United States) proposed a new trans-

mission hierarchy in 1985. Bellcore's major goal was to create a synchronous system with an optical interface compatible with multiple vendors, but the standardization also included a flexible frame structure capable of handling either existing or new signals and also numerous facilities built into the signal overhead for embedded operations, administration, maintenance and provisioning (OAM&P) purposes. The new transmission hierarchy was named Synchronous Optical Network (SONET). The International Telecommunication Union (ITU) established an international standard based on the SONET specifications, known as the *Synchronous Digital Hierarchy* (SDH), in 1988.

The SDH specifications define optical interfaces that allow transmission of lower-rate (e.g., PDH) signals at a common synchronous rate. A benefit of SDH is that it allows multiple vendors' optical transmission equipment to be compatible in the same span. SDH also enables dynamic drop-and-insert capabilities on the payload; PDH operators would have to demultiplex and remultiplex the higher-rate signal, causing delays and requiring additional hardware. Since the overhead is relatively independent of the payload, SDH easily integrates new services, such as Asynchronous Transfer Mode (ATM) and Fiber Distributed Data Interface (FDDI), along with existing European 2, 34, and 140 Mbit/s PDH signals, and North American 1.5, 6.3, and 45 Mbit/s signals. In 1990, the European Telecommunications Standards Institute (ETSI) selected a subset of the original SDH specification as the standard for use by members of the European Union (EU). This subset, now used by many countries outside the EU, is known as the *ETSI SDH* specification. ETSI SDH establishes a common multiplexing route for European countries. ETSI SDH differs from the full SDH specification in that ETSI SDH is more restricted in the available multiplexing/demultiplexing options for transporting European and North American plesiochronous signals. References to SDH in this document are exclusively the ETSI SDH subset.

## SDH Multiplexing

SDH multiplexing combines low-speed digital signals such as 2, 34, and 140 Mbit/s signals with required overhead to form a frame called Synchronous Transport Module at level one (STM-1). **Figure 1** shows the STM-1 frame, which is created by 9 segments of 270 bytes each. The first 9 bytes of each segment carry overhead information; the remaining 261 bytes carry payload. When visualized as a block, the STM-1 frame appears as 9 rows by 270 columns of bytes. The STM-1 frame is transmitted row #1 first, with the most significant bit (MSB) of each byte transmitted first.

This formula calculates the bit rate of a framed digital signal:

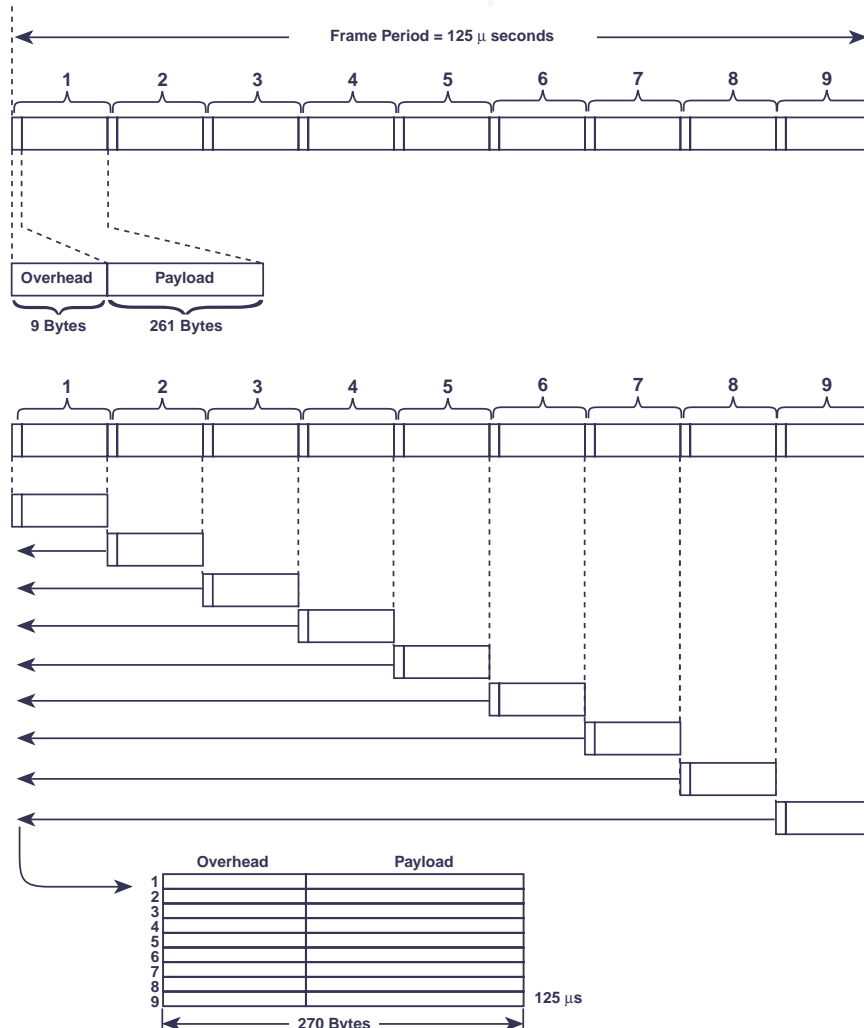
$$\text{bit rate} = \text{frame rate} \times \text{frame capacity}$$

In order for SDH to easily integrate existing digital services into its hierarchy, it operates at the basic rate of 8 kHz, or 125 microseconds per frame, so the frame rate is 8,000 frames per second. The frame capacity of a signal is the number of bits contained within a single frame. **Figure 1** shows:

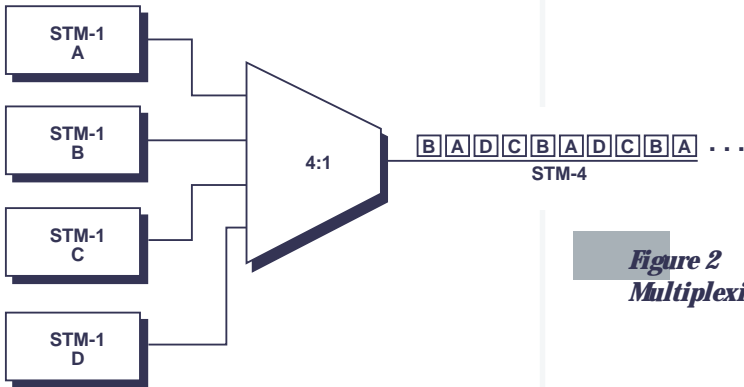
$$\text{frame capacity} = 270 \text{ bytes/row} \times 9 \text{ rows/frame} \times 8 \text{ bits/byte} = 19,440 \text{ bits/frame}$$

The bit rate of the STM-1 signal is calculated as follows:

$$\begin{aligned} \text{bit rate} &= 8,000 \text{ frames/second} \times 19,440 \text{ bits/frame} \\ &= 155.52 \text{ Mbit/s} \end{aligned}$$



**Figure 1**  
**The STM-1 Frame**



**Figure 2**  
**Multiplexing STM-1s**

Three transmission levels (STM-1, STM-4, and STM-16) have been defined for the SDH hierarchy. As **Figure 2** shows, the ITU has specified that an STM-4 signal should be created by byte interleaving four STM-1 signals. The basic frame rate remains 8,000 frames per second, but the capacity is quadrupled, resulting in a bit rate of  $4 \times 155.52$  Mbit/s, or 622.08 Mbit/s. The STM-4 signal can then be further multiplexed with three additional STM-4s to form an STM-16 signal. **Table 1** lists the defined SDH frame formats, their bit rates, and the maximum number of 64 kbit/s telephony channels that can be carried at each rate.

| Frame Format | Bit Rate      | Max. Number of Telephony Channels |
|--------------|---------------|-----------------------------------|
| STM-1        | 155.52 Mbit/s | 1,920                             |
| STM-4        | 622.08 Mbit/s | 7,680                             |
| STM-16       | 2.488 Gbit/s  | 30,720                            |

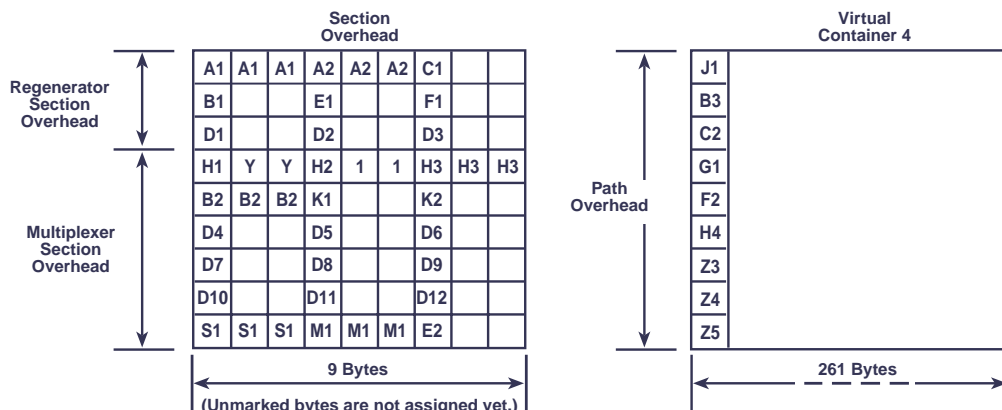
**Table 1**  
**SDH Levels**

## The SDH Frame

**Figure 3** shows the STM-1 frame divided into two parts to physically segregate the layers, where each square represents an 8-bit byte. The first nine columns comprise the section overhead (SOH), while the remainder is called the virtual container at level four (VC-4). The SOH dedicates three rows for the regenerator section overhead (RSOH) and six rows for the multiplexer section overhead (MSOH). The VC-4 contains one column for the VC-4 path overhead (VC-4 POH), leaving the remaining 260 columns for payload data (149.76 Mbit/s). Refer to **Figure 3** to visualize the location of the SDH overhead in the STM-1 frame.

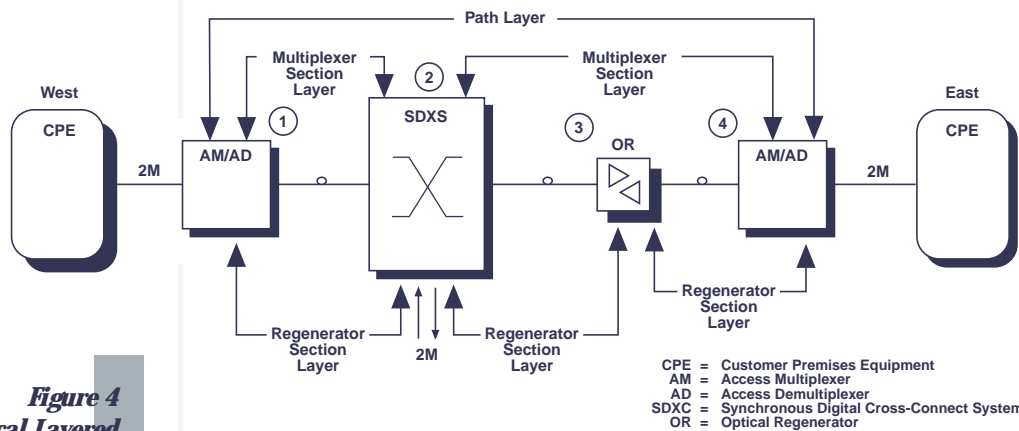
See **Appendix A** for more information on each of these overhead bytes.

**Figure 3**  
**Basic SDH Overhead Structure**



## SDH Signal Hierarchy

The SDH signal is layered to divide responsibility for transporting the payload through the network. Each SDH network element (NE) is responsible for interpreting and generating its overhead layer, and for communicating control and status information to the same layer in other equipment, or *terminating* its overhead layer. As the payload travels through the SDH network, each layer is terminated by one of a general class of NEs named regenerator section terminating equipment (RSTE), multiplexer section terminating equipment (MSTE), or path terminating equipment (PTE). **Figure 4** depicts a sample network with the layered functions identified. The POH is generated where the lower-rate non-SDH signal enters the SDH network by a PTE, such as an access multiplexer (AM). The POH is removed when the payload exits the SDH network by a PTE, such as an access demultiplexer (AD). The POH is first-on, last-off, so the alarm and error information contained within this layer represents end-to-end status.



**Figure 4**  
*Typical Layered  
Communication  
Network*

The next layer of overhead termination is the MSOH and is performed by the MSTE such as a synchronous multiplexer (SM), a synchronous digital cross-connect system (SDXS), an AM, or an AD. The MSOH is where most of the communication and synchronization between major nodes occurs and monitors error information between major network nodes. Finally, RSOH is terminated by RSTEs, such as optical regenerators (ORs), SMs, SDXSs, AMs, or ADs, and contains error information between every node in the SDH network. As **Figure 4** shows, MSTE, PTE, and RSTE functions may sometimes be combined within the identical piece of equipment. Since each layer is terminated and regenerated at the appropriate nodes, the performance monitoring data at each network node helps to sectionalize problems.

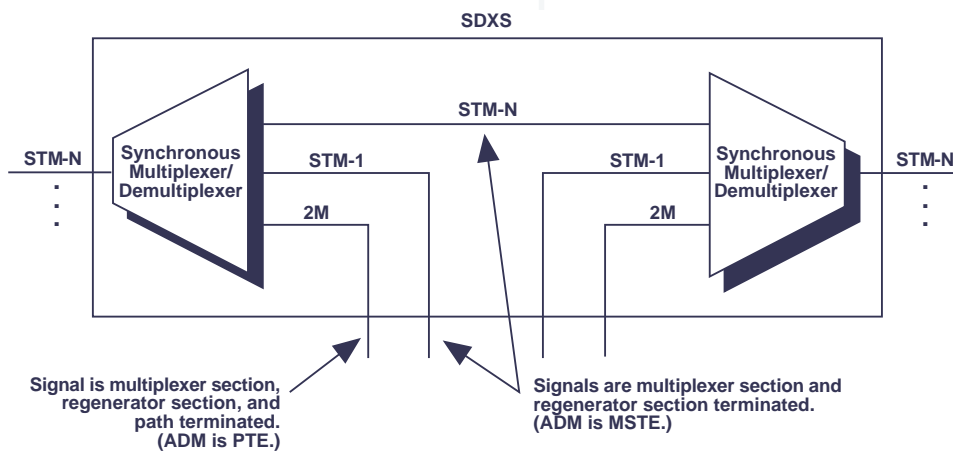
For example, if traffic is traveling west to east in **Figure 4**, and regenerator section errors are detected at Site 4, a problem will be somewhere between Site 3 and Site 4. The observed problem can not be west of Site 3, since all regenerator section results are recalculated at every point in the network. If multiplexer section errors are found at Site 4, a problem exists between Site 2 and Site 4, since multiplexer section results are recalculated only at major network nodes, such as the SDXS at Site 2. Furthermore, if multiplexer section errors, but not regenerator errors, are found at Site 4, then a problem exists between Site 2 and Site 3. Finally, if path errors are detected at Site 4, then a problem exists anywhere between Site 1 and Site 4.

The SDXS at Site 2 adds a twist to the path errors example, due to its flexible functionality, as shown in **Figure 5**. A SDXS has the capability to drop and insert signals, and functions as a PTE when the signals being dropped or added are tributaries of the SDH signal. If the SDXS has been equipped to add and drop 2, 34, or 140 Mbit/s PDH signals, the SDXS functions as a PTE for those signals.

If it is equipped to add and drop STM-N signals, the SDXS functions only as a MSTE for those signals. This fact must be considered in the scenario in **Figure 4**. The path statement must be modified to add the condition that if path errors are located at Site 4, and the origin of a non-SDH tributary within the STM-1 is at Site 1, then a problem exists

between Site 1 and Site 4. Otherwise, if any non-SDH tributary within the STM-1 originates from Site 2, then a problem exists between Site 2 and Site 4. Therefore, in troubleshooting a signal, it is important to know where the path originates.

Since the origin of the signal is an important factor in isolating trouble spots, the SDH signal itself provides a method to tag every STM-1 with information about its location. The J1 Path Trace byte, described in **Appendix A**, carries a fixed length, either 16 or 64-byte, American Standard Code for Information Interchange (ASCII) string that can be programmed at system turn-up to carry textual information about the originating node, office, or customer. Because this information is never terminated by MSTEs or RSTEs, it can only be assigned at the signal originating point. The C1 and J2 bytes provide similar functionality.



**Figure 5**  
**Function of a SDH SDXS**

## SDH Performance Monitoring

Each layer in the SDH signal provides alarm and error monitoring capabilities between various terminating points in the network. Similar to 2 Mbit/s signals, parity is calculated and stored in the transmitted signal. The parity is recalculated by the receiver and verified against the stored value to determine if an error occurred during transmission. Every layer in the SDH signal has its own Bit Interleaved Parity (BIP) calculation. The sidebar below shows how BIP checks are performed in SDH.

If CRC framing is used at the 2 Mbit/s level, a Remote End Block Error (REBE) may be returned to the

sender when a bit error is detected in the framed 2 Mbit/s PDH signal. SDH uses the same algorithm, using a layered approach. If a MSTE receives some number of multiplexer section BIP errors, it transmits the same number of multiplexer section Far End Block Errors (FEBEs) back to the originator. PTEs use the same approach in the path layer of overhead.

Like 2, 34, and 140 Mbit/s PDH signals, the SDH signal also contains Alarm Indication Signals (AISs) and Remote Alarms, except that a SDH Remote Alarm is called Remote Defect Indication (RDI), and is layered like all of the other SDH results. The term RDI replaces the former names FERF (Far End Receive Failure) and RAI (Remote Alarm Indication) from previous versions of the SDH specification.

### Bit Interleaved Parity (BIP)

BIP calculations are performed over each layer of the SDH overhead, such that each bit in the BIP byte will indicate the parity of all respective bits in the previous frame. For example, if the number of bits equaling one in the first bit position of every byte is odd, then the first bit position of the BIP byte will be one. If the number of ones in the first position is even, then the first bit position of the BIP byte will be zero. This is repeated for all eight bits of each byte to determine the value of the BIP byte.

```

Bytes in
Transmitted Signal = 01100100
                    10000110
                    . . . . .
                    10100110
BIP Calculation    = 01000100
    
```

Each layer calculates the BIP for all information in its domain. For example, the entire SDH signal is formed when the RSTE sees it, so the regenerator section BIP is calculated over the entire signal, including all RSOH, MSOH, VC-4 POH, and payload of the previous STM-N frame. The result is then placed in the B1 byte for a STM-1. Multiplexer section BIPs are calculated over the previous STM-1 frame, minus the RSOH, and placed in the B2 bytes. Path BIPs are calculated over the previous frame, minus RSOH and MSOH, and are found in the B3 byte of every STM-1.

## SDH Timing Compensation

The SDH signal was designed to be timing-tolerant to support plesiochronously timed, lower-rate signals and slight timing differences between synchronously timed NEs. Two mechanisms allow for robust timing compensation: variable bit justification of the lower-rate signal, and a technique called *pointer adjustments* between synchronous elements in the SDH network.

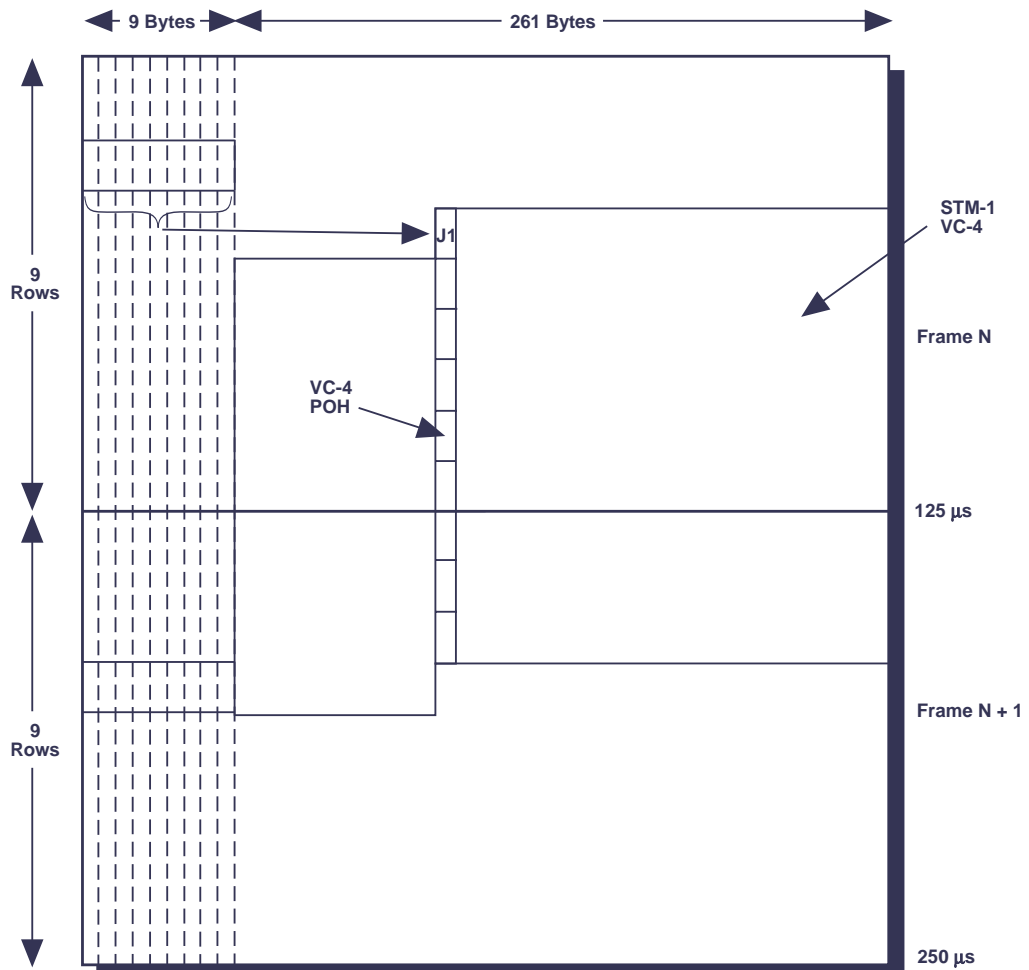
Pointer adjustments allow the VC-4 to float with respect to the SDH frame. This means that a single VC-4 payload frame typically crosses the STM-1 frame boundary, as **Figure 6** shows. The pointer is contained in the H1 and H2 bytes of the MSOH, and it is a count of the number of bytes the VC-4 POH J1 byte is away from the H3 bytes, not including the section overhead bytes. A valid VC-4 pointer can range from 0 to 782.

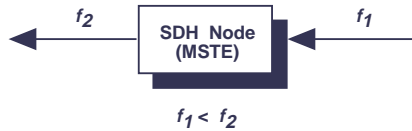
When timing differences exist, dummy bytes can be inserted into the VC-4 without affecting the data. Since

the pointer is adjusted to indicate where the real POH starts, the receiving end can effectively recover the payload (i.e., ignore the dummy bytes). When *justified* bytes are used, they are always in the same location, regardless of where the POH starts. H3 bytes are called *negative justification bytes* and carry real payload data for one frame during a pointer decrement. The three bytes following the last H3 byte in the VC-4 are called *positive justification bytes* and carry three dummy bytes of information for one frame during a pointer increment.

If there is no timing difference between two nodes, the incoming STM-1 payload bit rate is identical to the transmitting source that drives the outgoing STM-1 frame rate, so no pointer adjustments are needed. **Figure 7** shows a SDH node that has an incoming frequency  $f_1$  and an outgoing frequency  $f_2$ . If  $f_1$  is less than  $f_2$ , there is a constant lack of payload data to place into the outgoing SDH signal. To compensate, three dummy bytes are placed into the positive stuff bytes and the data is moved to the right by three bytes, so the VC-4 pointer is incremented by one (**Figure 8**). On the other hand, if  $f_1$  is greater than  $f_2$  (as shown in **Figure 9**), then

**Figure 6**  
*Pointer Bytes Designating the Start of the VC-4 Path Overhead*



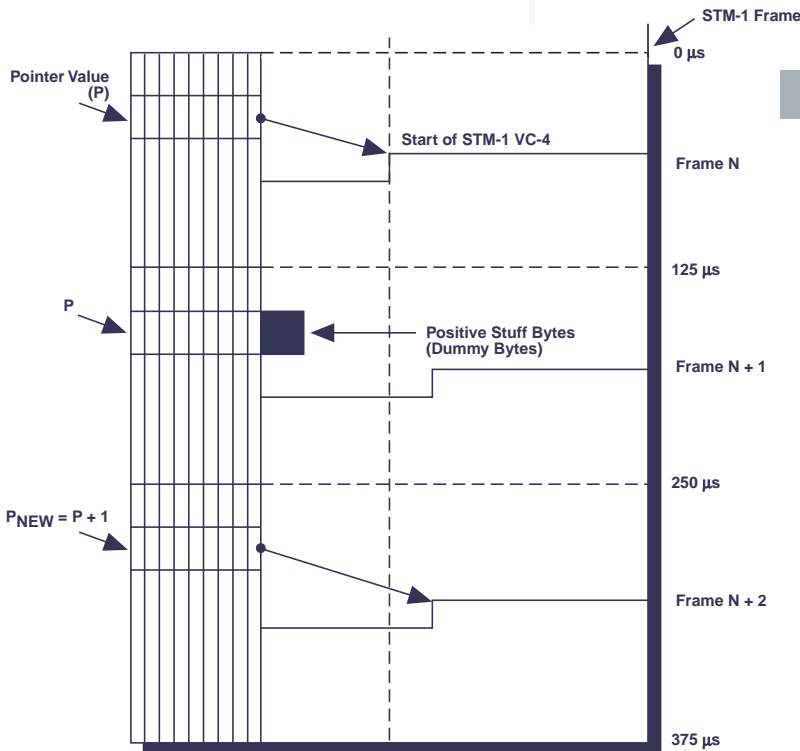


**Figure 7**  
*Node with Slower Incoming Data Rate*

three extra VC-4 payload bytes are stored into the negative stuff bytes, H3, in the MSOH for one frame, while all the payload data is moved to the left by three bytes and the pointer is decreased by one (**Figure 10**).

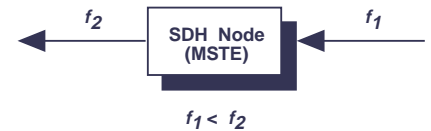
The only equipment that can perform path pointer adjustments is MSTE, since the pointer value is contained

in the MSOH. Also, path pointer adjustments are not performed by PTE (where the payload data enters the SDH network) even though there are potential timing differences at these locations as well. The timing differences at PTEs are due to plesiochronously-timed tributary signals and are corrected by traditional bit justification techniques.

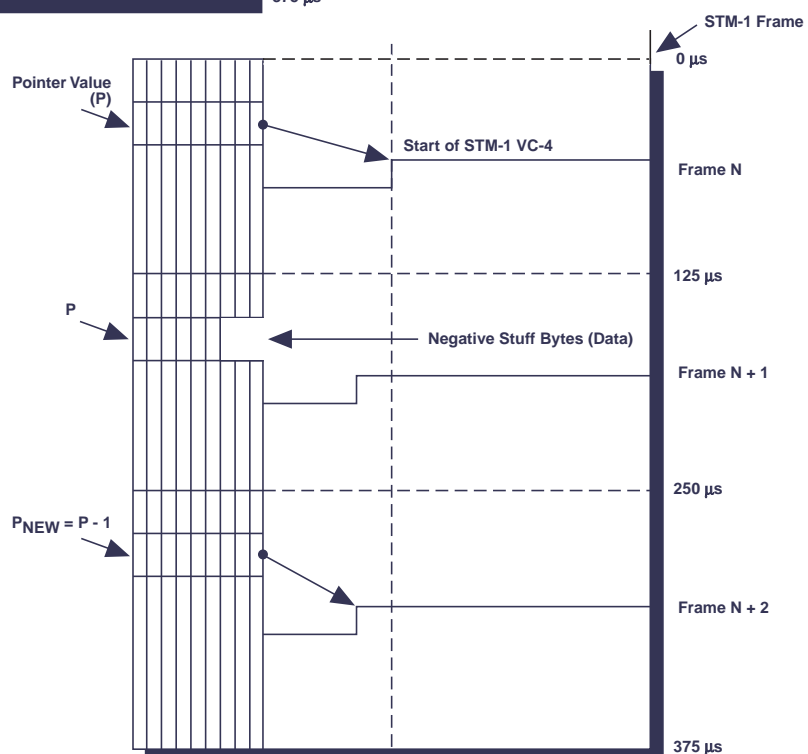


**Figure 8**  
*Incrementing the Pointer Value*

**Figure 9**  
*Node with Faster Incoming Data Rate*



**Figure 10**  
*Decrementing the Pointer Value*



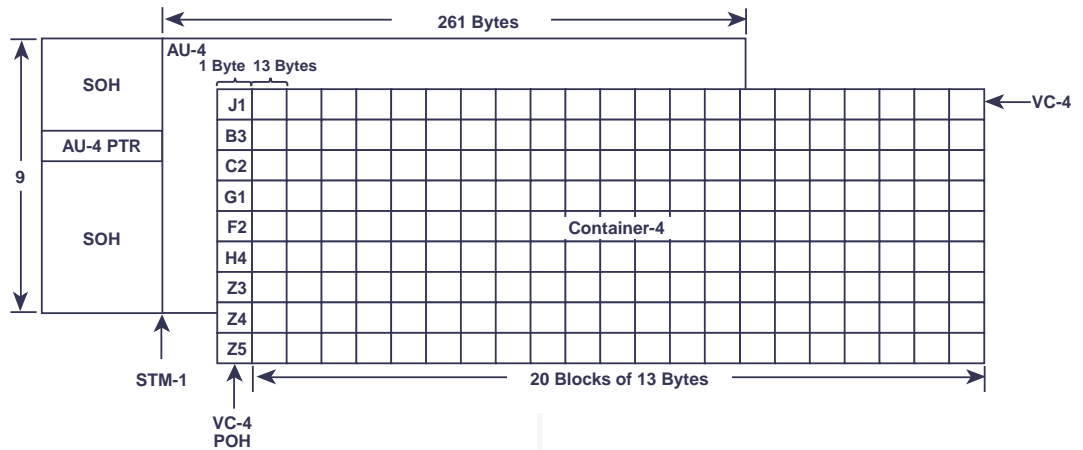
## 140 Mbit/s Payload Multiplexing

In SDH terms, multiplexing of non-SDH signals means adapting these signals to the structure and timing of an STM-1 signal, enabling these non-SDH signals to be transported inside the SDH network. The first step in the multiplexing of a non-SDH signal is *mapping*. Mapping of a non-SDH signal means increasing the frequency of the non-SDH signal to a pre-determined frequency and adding overhead for each one of the non-SDH signals.

The SDH multiplexing that defines 140 Mbit/s transport is asynchronous 140 Mbit/s. It is the least flexible SDH multiplexing mode, because 140 Mbit/s is the lowest level that can be cross-connected without incurring the delay and hardware cost of demultiplexing the entire SDH signal. Even though this multiplexing is less flexible than multiplexing 2 Mbit/s signals straight into SDH, it is the most important one because this level

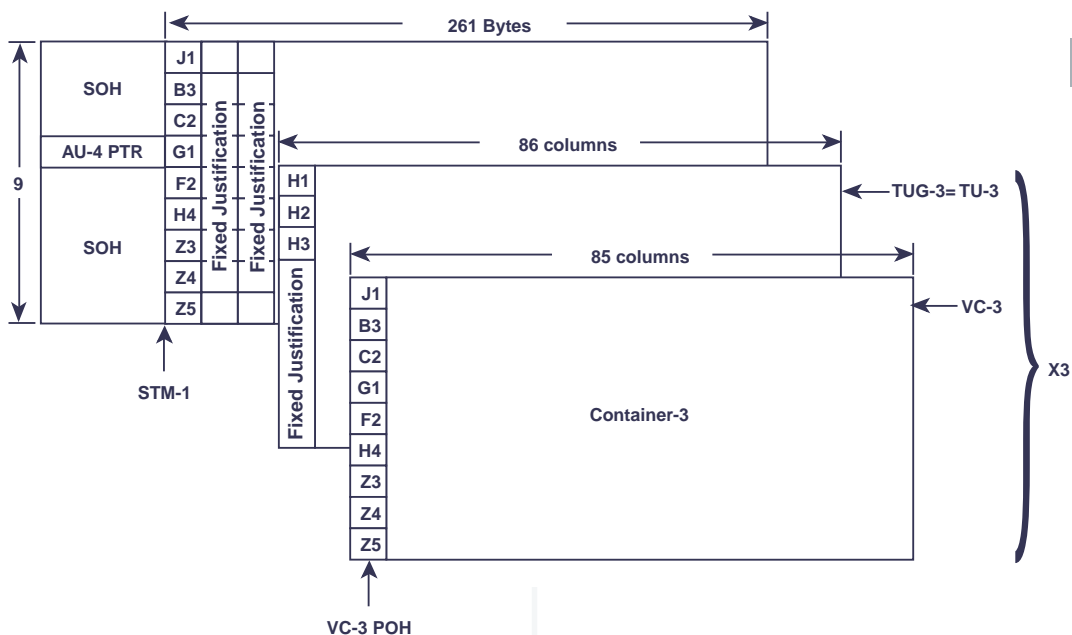
of multiplexing is needed to allow transport of the large number of 140 Mbit/s signals that already exist in networks throughout the world.

Multiplexing a 140 Mbit/s PDH signal into a STM-1 signal requires a number of steps. The first step is increasing the frequency of the 140 Mbit/s signal to the value of 149.76 Mbit/s, by using variable bit justification. The resulting structure is called a container at level four (C-4). Next, add nine overhead bytes to the C-4; this overhead is called path overhead (POH). These nine bytes are: J1, B3, C2, G1, F2, H4, Z4, and Z5, and the resulting structure is called a virtual container at level four (VC-4). See *Appendix A* for a description of each of these nine bytes. The second step is the addition of a VC-4 pointer. The resulting structure is called an administrative unit at level four (AU-4). Finally, MSOH and RSOH are added to the AU-4 to create the STM-1 signal. See *Appendix A* for a description of each of these section overhead bytes. *Figure 11* shows how a 140 Mbit/s signal is accommodated into an STM-1 signal.



**Figure 11**  
**Multiplexing a**  
**140 Mbit/s**  
**Signal into a**  
**STM-1 Stream**





**Figure 12**  
**Multiplexing**  
**Three 34 Mbit/s**  
**Signals into a**  
**STM-1 Stream**

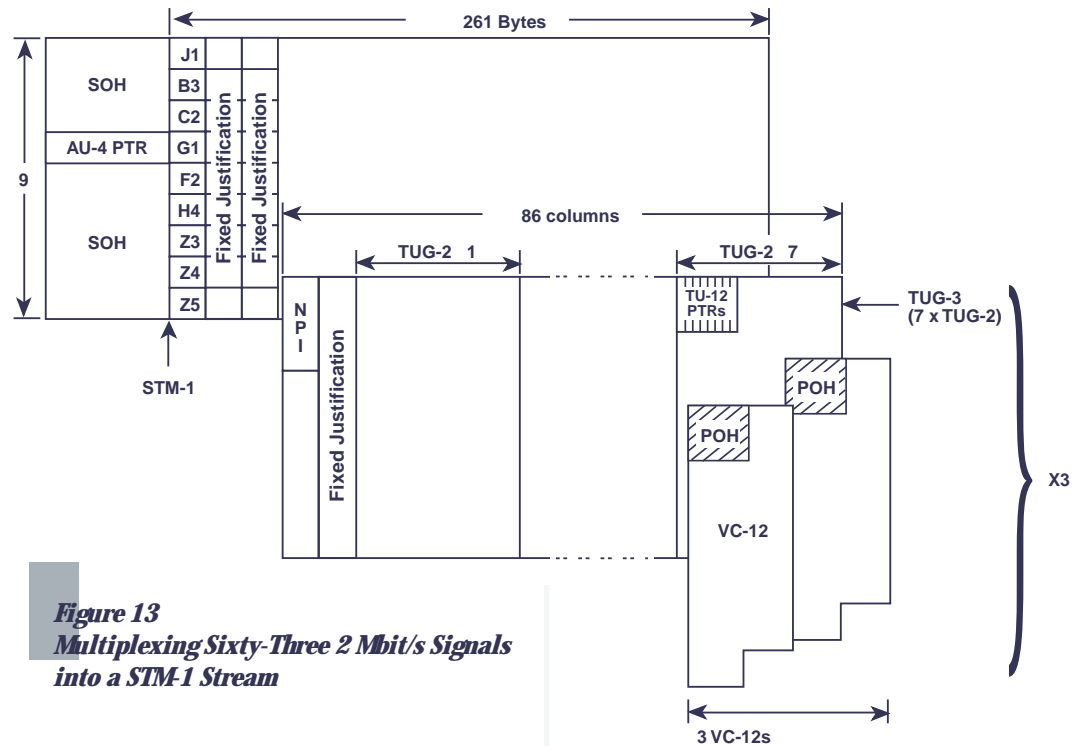
## 34 Mbit/s Payload Multiplexing

The multiplexing of 34 Mbit/s signals into an STM-1 is similar to that of 140 Mbit/s signals. The major difference is that, because a VC-4 has a maximum payload capacity of 149.76 Mbit/s, it can transport three 34 Mbit/s signals. Each of the three transported 34 Mbit/s signals is assigned a separate set of POH identical to the POH used with the 140 Mbit/s signal. Another difference is that there are two levels of pointers: one pointer for the VC-4, and one separate pointer for each of the three 34 Mbit/s signals. The synchronized 34 Mbit/s signals are called containers at level three (C-3s), and the structures created by adding the POH are called virtual containers at level 3 (VC-3s). The three VC-3s along with their pointers are called tributary units at level three (TU-3s). Once the three TU-3s have been created, they are combined to form the payload of the VC-4. **Figure 12** shows how three 34 Mbit/s signals are accommodated into a STM-1 signal.

## 2 Mbit/s Payload Multiplexing

When developing the SDH standard, the ITU excluded the multiplexing of individual 8 Mbit/s PDH signals into an STM-1. This is because, in most regions of the world, the 8 Mbit/s PDH level is commonly used as an *intermediate* multiplexing level. The use of 2-34 Mbit/s multiplexers/demultiplexers, sometimes called skip multiplexers (that can combine sixteen 2 Mbit/s links into a 34 Mbit/s signal), is common in most PDH networks.

The multiplexing of 2 Mbit/s signals into a STM-1 is similar to that of 34 Mbit/s signals. In this case, the STM-1 signal can transport 63 separate 2 Mbit/s signals. Therefore, as in the case of 34 Mbit/s signals, there are two levels of pointers. Also, the POH assigned to each 2 Mbit/s signal is different from that used in 140 and 34 Mbit/s signals. The POH for a 2 Mbit/s signal consists of four bytes, namely, V5, J2, Z6, and Z7. **Appendix A** describes each of these four bytes. Unlike mapping of 140 and 34 Mbit/s signals, the types of 2 Mbit/s mappings are: asynchronous, bit synchronous, and byte synchronous. Each container at level 1, order 2 (C-12) along with its POH is called a virtual container at level 1, order 2 (VC-12). Each VC-12 along with its VC-12 pointer is called a tributary unit at level 1, order 2 (TU-12). The payload of the VC-4 is created by combining 63 TU-12s. **Figure 13** shows how these 2 Mbit/s signals are accommodated into an STM-1 signal. The sidebar below describes each of the three mappings, and typical uses for each. The mapping and mode that is used depends on the application and nature of the 2 Mbit/s signals.



**Figure 13**  
**Multiplexing Sixty-Three 2 Mbit/s Signals**  
**into a STM-1 Stream**

### Asynchronous Mapping

*Asynchronous mapping* means that the 2 Mbit/s signals are not synchronized to the SDH signal. Asynchronous mapping imposes no signal structure requirements, so 2 Mbit/s signals using this mapping do not need to be framed. This type of mapping allows an easy interface with existing PDH systems, because as in the case of 140 and 34 Mbit/s mappings, variable bit justification occurs as part of this type of 2 Mbit/s mapping, but direct access to 64 kbit/s timeslots is not possible.

### Bit Synchronous Mapping

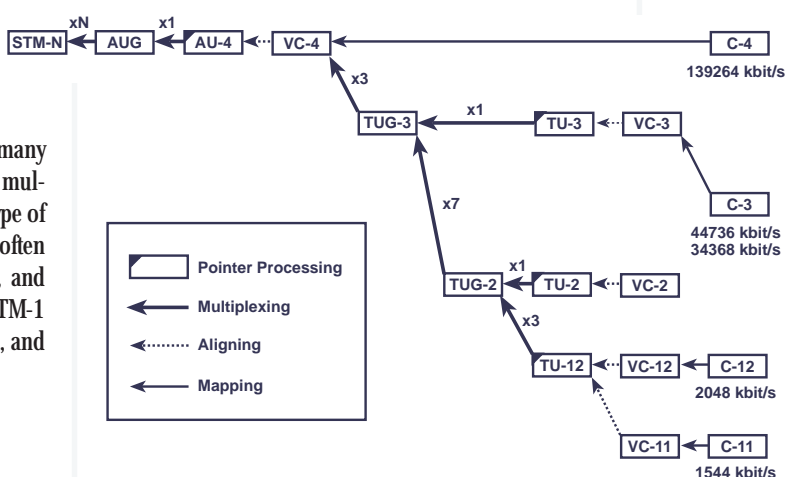
*Bit synchronous mapping* means that the rate of the 2 Mbit/s signal is synchronized to the SDH signal; however, the framing (if any) of the 2 Mbit/s signal is not synchronized to the SDH signal. As in the case of asynchronous mapping, bit synchronous mapping imposes no signal structure requirements, so 2 Mbit/s signals using this mapping do not need to be framed. Unlike asynchronous mapping, no variable bit justification takes place with bit synchronous mapping, so the 2 Mbit/s signals to be mapped must already be synchronized to the SDH network. This type of mapping is not planned for use in international networks; however, it may be used in national networks. As in the case of asynchronous mapping, this type of mapping imposes the restriction that direct access to 64 kbit/s timeslots is not possible.

### Byte Synchronous Mapping

*Byte synchronous mapping* means that both rate and the framing of the 2 Mbit/s signal are synchronized to the SDH signal. Byte synchronous mapping requires G.704 framing on the 2 Mbit/s signals. Because bit justification does not take place, the 2 Mbit/s signals to be mapped must already be synchronized to the SDH network. This mapping allows direct access to 64 kbit/s timeslots, so this should normally be used for Nx64 kbit/s services and most 2 Mbit/s signals in the SDH network. Originally, ITU defined two types of 2 Mbit/s byte synchronous mappings: floating mode and locked mode. The difference between these two lies in the use of the VC-12 pointers. *Floating mode* uses VC-12 pointers, but *locked mode* does not. *Locked mode* was developed as a means to avoid the use of VC-12 pointers, to eliminate the cost of VC-12 pointer processors in SDH equipment. Originally it was thought that the use of VC-12s pointers in many cases could be unnecessary. Whenever using VC-12 locked mode, all VC-12s are locked in phase and frequency, implying that switching of VC-12s in SMs or SDXSs may cause significant delays. This is one of the reasons why this mapping mode is limited to “special cases”, and is not intended to be widely used.

**Figure 14**  
**Multiplexing Plesiochronous Signals into a STM-N Signal**

For newly deployed networks, such as many being implemented in Central and Eastern Europe, multiplexing of 2 Mbit/s signals is the most important type of SDH multiplexing, because these networks are often designed to bypass the plesiochronous hierarchy, and instead multiplex 2 Mbit/s signals directly into the STM-1 level. **Figure 14** shows the steps to multiplex 2, 34, and 140 Mbit/s PDH signals into a STM-N signal.

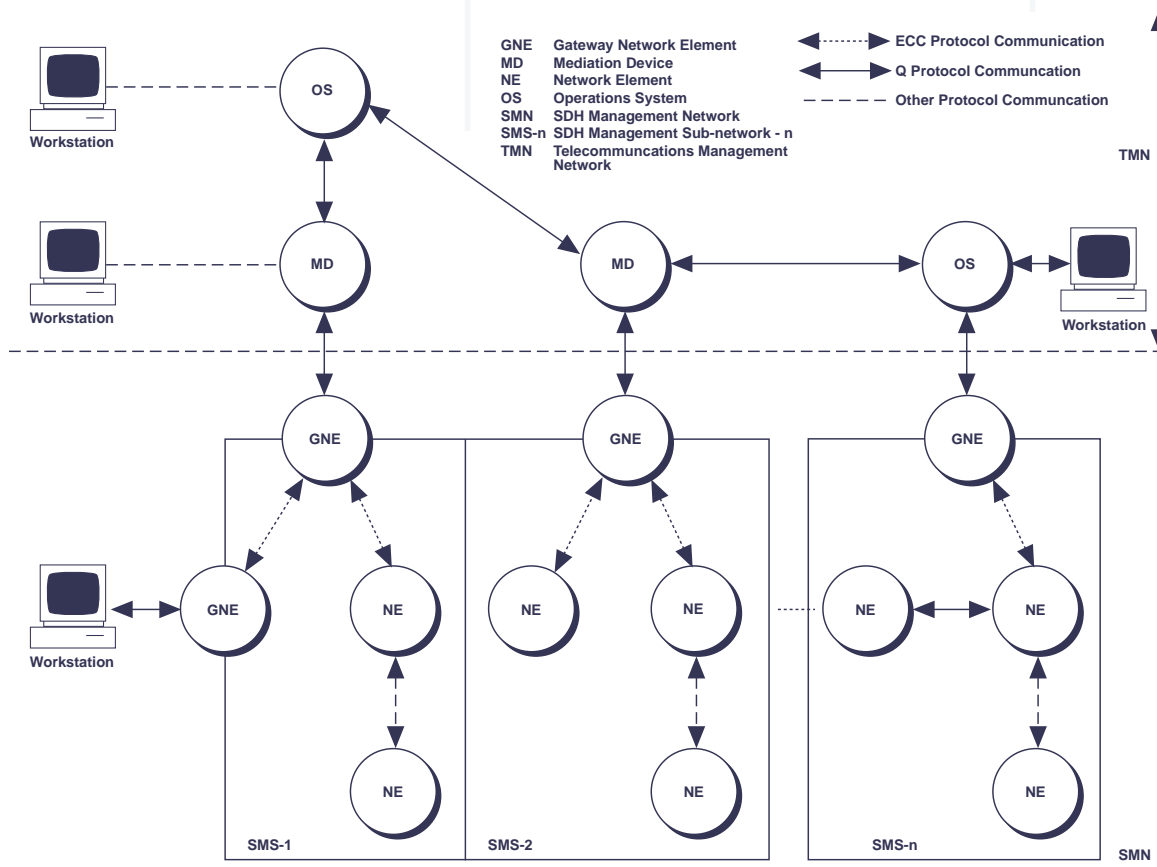


## SDH Network Management

One important benefit of SDH when compared to PDH is that SDH networks will operate together with a centralized, standardized control and maintenance system. The progressive incorporation of synchronous electronic cross-connect systems (SDXS) into the network will allow the deployment of OAM&P capabilities from centralized operations. This means that one centralized telecommunications management network (TMN) can be used for operation and maintenance of SDH NEs from different vendors. The TMN interfaces with a network at several different points to receive information

from it and control its operation. The ITU Telecommunication Standardization Sector (ITU-T) Recommendation M.3010 provides the general principles of a TMN. ITU-T Recommendation G.784 applies the principles of the TMN to SDH-based transmission systems. **Figure 15** shows the relationship between the SDH management network and a TMN. Information between the SDH Management Network (SMN) and the TMN is transferred through Q-interfaces. The SMN can be accessed by the TMN at Gateway Network Elements (GNE).

**Figure 15**  
**Relationship Between TMN and SMN in a SDH Network**



The SMN itself consists of a number of SDH Management Sub-Networks (SMSs). Communication within the SMSs is carried on Embedded Control Channels (ECCs) that use the Data Communication Channels (DCCs). DCCs are the D1 thru D12 bytes of the section overhead in a SDH signal. Some of the activities that a SDH management system addresses are security management, performance monitoring, ECC management, configuration management, and fault and maintenance management. SDH not only provides channels for management communications within the signal structure, but it also provides standard protocols for network management.

## SDH/PDH Network Testing Applications

This section describes some important tests for combined SDH/PDH networks and equipment, and some essential capabilities required for testing these networks and elements.

### Verification of SDH/PDH and SDH Network Equipment

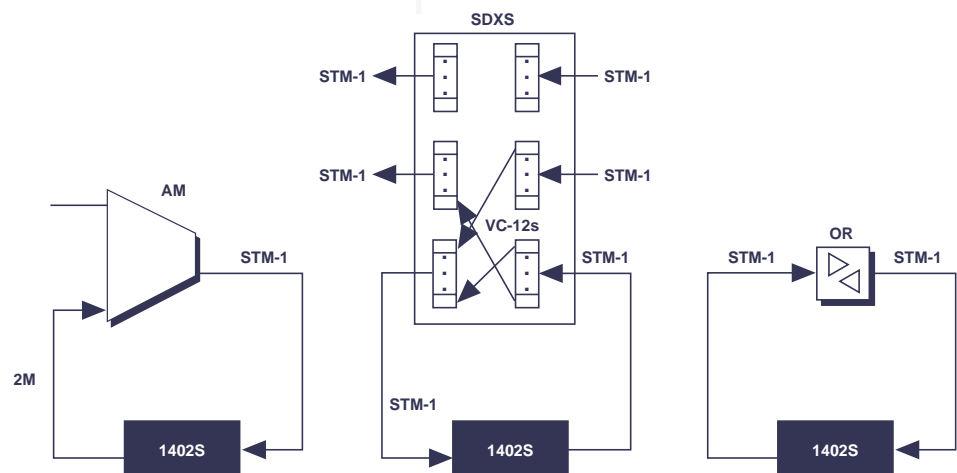
One important procedure to be carried out in SDH/PDH networks is verifying that NEs (SMs, AMs, ADs, SDXSs and ORs) comply with ITU-T recommendations. Generation and reception of both PDH and SDH signals at different levels are required for this application. The capability to multiplex/demultiplex both SDH and PDH signals is also required for complete testing. Also needed are the capability to insert and detect both SDH and PDH errors into the transmitted payload and overhead, and to

generate and detect both SDH and PDH alarms. Cable simulation capabilities are essential for signal recovery testing. Stress testing is usually performed once compliance with ITU-T recommendations has been verified. **Figure 16** shows wrap-around testing of SDH NEs.

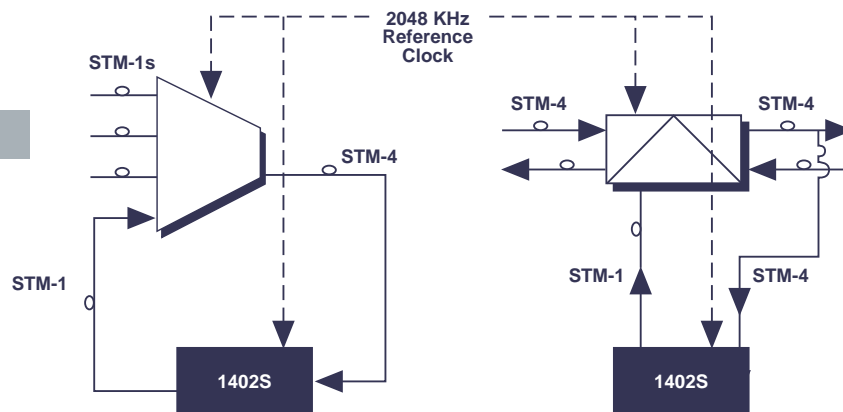
## Timing Analysis

Proper timing must also be verified in SDH/PDH networks. For this purpose, the capability to generate both SDH and PDH signals with frequencies beyond ITU-T recommended nominal values is required. In particular, the capability to synchronize the test instrument to an external 2048 kHz clock source, and the ability to generate SDH signals with frequencies deviated from ITU-T recommended nominal values are important to test pointer processors at NEs. Measurement of bit and frame slips at the SDH and PDH levels should also be available to verify clock recovery and distribution circuits. In addition, manipulation of pointer values should be available to verify correct pointer values recognition at NEs. This includes the capability to generate sequences of pointer values to analyze tolerance to tributary jitter at access demultiplexers. Capability to read and display S1 bytes in the section overhead of SDH signals is also necessary, so that correct processing of SDH synchronization status messages can be verified. **Figure 17** shows typical NEs to be tested for correct synchronization.

**Figure 16**  
*Wrap-Around Testing of SDH NEs*



**Figure 17**  
*Synchronization  
Testing of SDH NEs*



## In-Service Network Quality Verification

The capability to perform both in-service G.821 and in-service M.2100 performance analyses on the PDH tributaries of a SDH signal is required for non-intrusive network quality assessment. Block-based in-service performance analysis on the whole SDH signal for extensive testing is also required. Along with these capabilities, the ability to demultiplex a SDH signal through the Nx64 kbit/s level provides comprehensive service analysis of transmission links at all levels, which is useful to analyze network status under similar environmental conditions and network load. It is important to analyze the PDH payload and overhead inside SDH signals, including detection of PDH alarms, for testing purposes. **Figure 18** shows examples of monitoring points in a SDH/PDH network.

## Optical Fiber Media Testing

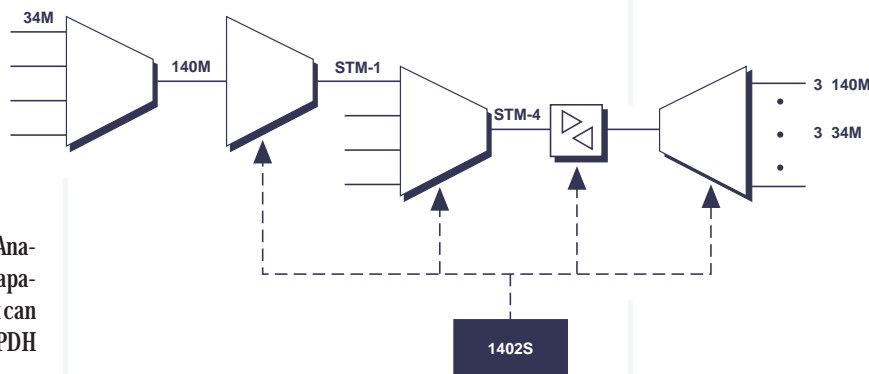
ITU-T recommends that SDH signals be transported over optical fibers. One major type of test in SDH networks is verification of the optical transmission medium. Two important parameters to be tested in optical fiber links are optical power level, and return loss.

The TTC INTERCEPTOR® 1402S SDH/PDH Analyzer is a versatile test instrument that includes the capabilities required in all test scenarios just described. It can be used to test both PDH-only and hybrid SDH/PDH circuits and equipment.

## Summary

The SDH signal has built-in performance monitoring, maintenance, provisioning, and operations information directly within the signal format. It contains mechanisms to allow for timing inconsistencies throughout the network, and provides a means for transporting a wide variety of services. It allows tributary drop and insert while reducing equipment cost and timing delay to provide on/off ramps to the industry analogy of the “global superhighway”. Rings may be designed to provide a high degree of service quality, even in the presence of multiple failure conditions. SDH networks will increasingly incorporate intelligent network elements for more flexible network configuration. These advantages add up to provide a powerful network standard that will continue to grow in popularity into the future. As SDH brings many new advances to the telecommunications network, it also brings many new testing challenges.

**Figure 18**  
*PDH/SDH  
In-Service  
Performance  
Analysis  
Evaluation*



## Appendix A

### SDH Regenerator Section, Multiplexer Section, and Path Overhead Layers

Many of the bytes in the tables of this appendix are undergoing further definition and/or modification at time of publication.

**Table 2**  
**SDH Regenerator**  
**Section Overhead**  
**Layer**

| Byte   | Name   | Description   |
|--------|--|---|
| A1-A2  | Framing Bytes                                  | Provide framing alignment for STM-N signals. For an STM-1, the pattern is A1A1A1A2A2A2, where A1 is 11110110 and A2 is 00101000.  |
| C1     | Section Trace                                  | Provides an indication of path connectivity by repeating either a single or 16 byte fixed length ASCII text string.   |
| B1*    | Regenerator Section BIP-8                      | Provides regenerator section error monitoring using a bit interleaved parity 8 code (BIP-8) using even parity. It is calculated over all bytes of the previous STM-N frame. |
| E1*    | Regenerator Section Orderwire                  | Provides a 64 kbit/s voice channel for communication between two RSTEs.   |
| F1*    | Regenerator Section User Channel               | Provides a 64 kbit/s channel reserved for user purposes, for example, to establish a temporary data or voice connection between RSTEs.                                      |
| D1-D3* | Regenerator Section Data Communication Channel | Provides a 192 kbit/s Data Communication Channel (DCC) between two RSTEs, to allow for message-based administration, monitoring and other communication needs.              |

\* Only defined for the first STM-1 of an STM-N

| Byte    | Name   | Description  |
|---------|--|--|
| H1-H2   | Pointer  | Provides a byte offset value to indicate where the path overhead begins within each VC-4. It is defined for all STM-1s within an STM-N.  |
| Y       | Filling Bytes                                  | These bytes are not currently used. They are fixed to the value 1001SS11, where S bits are unspecified. They are defined for all STM-1s within an STM-N.   |
| 1       | Filling Bytes                                  | These bytes are not currently used. They are fixed to the value 11111111. They are defined for all STM-1s within an STM-N.   |
| H3      | Pointer Action                                 | Three extra bytes are provided for negative byte justification needed to perform a pointer decrement without losing any data. They are defined for all STM-1s within an STM-N.   |
| B2      | Multiplexer Section BIP-24xN                   | Provides multiplexer section error monitoring using a bit interleaved parity 24xN code (BIP-24xN) using even parity. It is calculated over all bytes of the multiplexer section overhead and VC-4, excluding the regenerator section overhead of the previous STM-1 frame. |
| K1-K2*  | APS Bytes                                      | Provide Automatic Protection Switching signaling between two MSTEs. Bits 6, 7 and 8 of K2 are used to signal Multiplexer Section Remote Defect Indication (MS-RDI, 110), an alarm similar to PDH remote alarms.  |
| D4-D12* | Multiplexer Section Data Communication Channel | Provides a 576 kbit/s Data Communication Channel (DCC) between two MSTEs, to allow for message-based administration, monitoring and other communication needs.   |
| S1      | Synchronization Status Bytes/Growth            | Bits 5-8 of these bytes are used to specify the level of synchronization of the signal in which they are placed. Bits 1-4 are growth bits.   |
| M1      | Multiplexer Section FEBE/Growth                | These bytes are used to implement Multiplexer Section Far End Block Error (MS-FEBE), a count of the number of BIP-24xN errors. This is valid only for levels 1 and 4. Additional bits are reserved for growth.   |
| E2*     | Multiplexer Section Orderwire                  | Provides a 64 kbit/s voice channel for communication between two MSTEs.  |

\* Only defined for the first STM-1 of an STM-N

**Table 3**  
**SDH Multiplexer**  
**Section Overhead**  
**Layer**

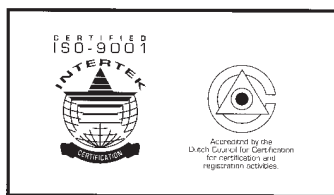
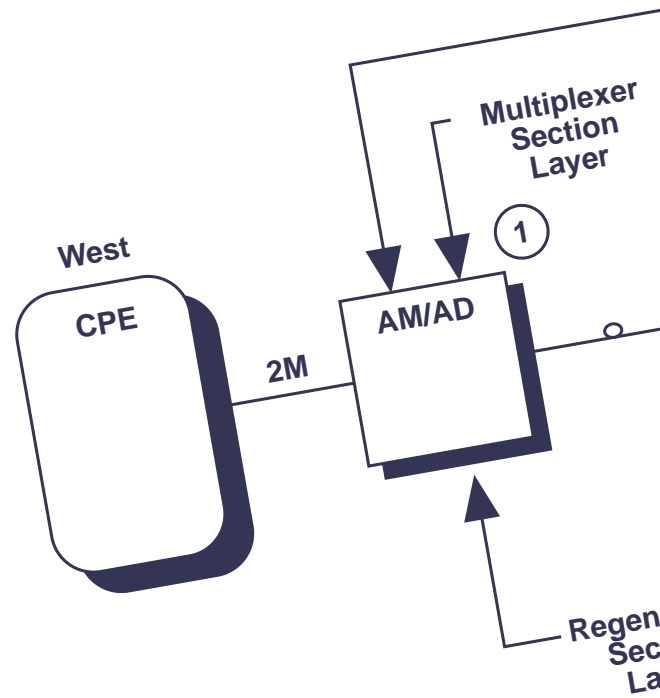
**Table 4**  
**SDH Path**  
**Overhead Layer**

| Byte  | Name                           | Description   |
|-------|--------------------------------|---|
| J1    | VC-4, VC-3<br>Path Trace       | Provides an indication of path connectivity by repeating either a 16 or 64 byte fixed length ASCII text string which is inserted when the payload is mapped. Installation crews can modify the string to indicate the tributary source.         |
| B3    | VC-4, VC-3<br>Path BIP-8       | Provides VC-4, VC-3 path error monitoring using a BIP-8 with even parity. It is calculated over all bytes of the previous VC-4/VC-3.  |
| C2    | VC-4/VC-3<br>Signal Label      | Provides information about the content of the VC-4/VC-3, which could contain no valid signal, an 140 Mbit/s PDH signal, 34 Mbit/s signals, 2 Mbit/s signals, ATM cells, Distributed Queue Dual Bus (DQDB) signals, or even FDDI signals.        |
| G1    | VC-4/VC-3<br>Path Status       | Provides a method for communicating the far-end path status back to the originating equipment. Both VC-4/VC-3 FEBE and RDI are implemented here.  |
| F2    | VC-4/VC-3<br>Path User Channel | Provides a 64 kbit/s channel reserved for user purposes, for example, to establish a temporary data or voice connection between VC-4/VC-3 PTEs.   |
| H4    | Multiframe Indicator           | Provides a multiframe phase indication of a Tributary Unit (TU) payload whenever transporting 1.544 Mbit/s or 2 Mbit/s signals.   |
| Z3-Z5 | Growth Bytes                   | These three bytes are reserved for future needs. For example, Z5 is allocated for specific management purposes, such as Tandem Connection Maintenance (TCM).  |
| V5    | VC-12 Path Overhead            | Provides a method for communicating the far-end path status back to the originating equipment. A BIP-2 code is implemented to monitor for errors. VC-12 FEBE and VC-12 RDI, are implemented here. A bit is also dedicated to indicate failures. |
| J2    | VC-12 Path Trace               | Provides an indication of path connectivity by repeating a 16-byte fixed length ASCII text string which is inserted when the payload is mapped. Installation crews can modify the string to indicate the tributary source.                      |
| Z6-Z7 | Growth Bytes                   | These two bytes are reserved for future needs. In particular, Z6 is allocated for specific management purposes, such as Tandem Connection Maintenance (TCM).  |



**DO NOT PRINT  
THIS PAGE**

~~pg. 17~~



**Telecommunications Techniques Corporation**  
20400 Observation Drive, Germantown, Maryland 20876  
Tel. (800) 638-2049 • (301) 353-1550 (MD) • FAX (301) 353-0731  
WWW Address: <http://www.ttc.com>

