

The HOTCHEK: Expanded Scale Voltmeter and Battery Tester

C. Brent Dane
AMA 345702

Summary

A small and easy to build device (shown in Fig. 1) based on the LM3914 voltage measurement integrated circuit (IC) can be used to measure the output voltage of rechargeable battery packs. A built in discharge circuit places a 300mA load on the battery that can be activated by the press of a button. The application of this load is very important since the stability of the battery's voltage under current drain is an important indication of its charge state. The HOTCHEK's small size and weight allow it to be installed onboard an R/C vehicle or alternatively, it can be used as a convenient "pocket-sized" battery checker. Component values are provided for both 4 and 5 cell NiCd (nickel cadmium) receiver packs as well as for 8 cell transmitter packs. Also, a simple set of formulas is presented to adjust the voltage range for other battery testing applications, including 12V lead-acid field batteries.

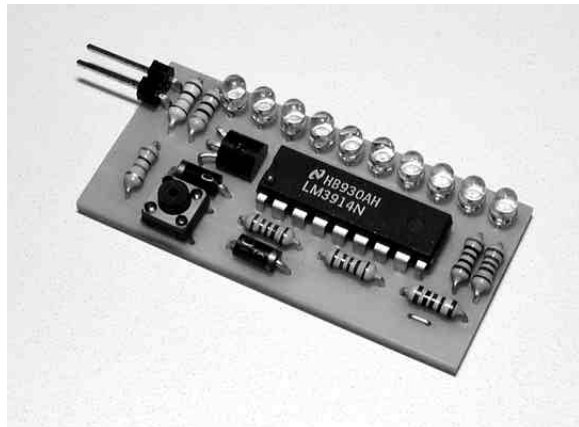

Fig. 1 Component installation details of the HOTCHEK circuit.

Measuring battery capacity

The rechargeable NiCd batteries that we use to power our radio control equipment have fairly flat discharge curves. That is, they deliver their stored energy (charge) with only a moderate

reduction in output voltage. This is great since it allows our radio transmitter, receiver, and servos to operate near full power between battery charging. The disadvantage, however, comes when one wants to determine how much of the remaining stored charge is available in the pack. Since the voltage doesn't dramatically decrease as the battery charge is exhausted, it is not necessarily a simple matter to determine the state of charge of the battery pack by measuring its voltage.

The capacity of a rechargeable battery (or battery pack) is generally specified in milliampere hours (mAh). Typical NiCd or NiMH (nickel metal hydride) cells range in capacity from 250 to over 2000mAh. The most reliable way of determining the amount of stored energy in a battery pack is to completely discharge it, sometimes referred to as cycling. If the pack is discharged at constant current, then the capacity can be calculated by multiplying the discharge rate in milliamperes by the discharge time in hours. For NiCd batteries, the discharge time is usually defined as the time required for each cell to reach a voltage of 1.1V. Fig. 2 shows a discharge curve for a typical 600mAh 4-cell NiCd battery pack that was discharged at a constant current of 330mA using a commercially available battery cycler. The pack takes two hours to go from its starting voltage of 5.9V (freshly charged) to 4.4V, corresponding to 1.1V per cell. This results in a measured capacity of $2\text{h} \times 330\text{mA} = 660\text{mAh}$. There are a number of interesting things that can be observed in the discharge plot shown in Fig. 2. First, note that the output voltage of the pack drops very quickly from a freshly charged voltage of almost 6V to 5V. After reaching 5V, however, the voltage drops gradually at a nearly constant rate for the remaining discharge time until it reaches 4.5V. The discharge plot also illustrates why 4.4V, or 1.1V per cell, is used as the end of the discharge cycle. Below 4.4V, the battery pack voltage drops drastically, with very little additional stored energy available. It is generally advisable to terminate the battery discharge cycle at 1.1V per cell but for illustration purposes, this was not done here.

Although Fig. 2 illustrates a useful way of measuring battery capacity, it does not represent well the way rechargeable batteries are generally used in R/C applications. Usually

we call our batteries into action for periods of 10-30min at a time with a recovery period in between. In an effort to more closely simulate this mode of operation, the discharge cycle was repeated with a freshly charged pack. This time the 330mA constant current load was engaged for 20 minutes periods spaced by 40 minute rest intervals. The data points were collected every 5 seconds by a computer and the results are shown in Fig. 3. Notice that after each of the first four discharge periods, the battery pack voltage recovers after a few minutes to over 5V. However, the fifth twenty minute discharge cycle takes the pack right up to the edge of exhaustion, with a loaded voltage down to almost 4V. After this last discharge cycle, the unloaded battery voltage recovers to only 4.9V. When the 330mA load is engaged one more time, the voltage drops off the bottom of the scale and the pack is down for the count!

Some care should be taken not to over interpret the results in Fig. 3, recognizing that R/C radio gear doesn't place a well-defined, constant electrical load on the battery pack. The actual current draw depends on the number of servos, the size of the mechanical loads on the servos, and the battery drain from other accessories. Also, exact battery voltage and current characteristics vary from pack to pack due to variations in cell ratings, design, and methods of manufacture. However, there are a couple of important pieces of information from Fig. 3 that I believe can be applied generally. First, it can be clearly seen that for a 4-cell NiCd pack to have useful charge remaining to power your equipment, the unloaded voltage should, after a short period of rest, exceed 5V. If it doesn't, it should not be used before being recharged. The second important battery pack test shown in Fig. 3 is illustrated by the rapid voltage drop-off when the current load is reapplied to the exhausted cells at the beginning of the sixth discharge cycle at the 300 minute mark. Notice that at the beginning of all the previous discharge cycles, the voltage drops only a few tenths of volts (0.1-0.2V) in the first 10 seconds (two data points) and then stabilizes to a very slow decline. However, when the current load is applied to the exhausted pack, the voltage drops and does not stabilize, continuing to quickly fall.

Fig. 3 also shows that the voltage to which the battery pack recovers between uses is directly

related to the remaining useful charge in the pack. The rested open circuit (no load) voltage is reduced by about 0.1V after each discharge cycle. In theory, this voltage could be used to predict the remaining energy that can be extracted from the batteries. However, this is only possible if one is very familiar with the discharge characteristics of their specific battery pack, also recognizing that these characteristics may change as the batteries age. For this reason, my recommendation is that voltage measurements not generally be used to try to predict the exact state of charge of the pack. However, as was just seen, voltage measurements can be used to make sure that the pack is not dangerously near the end of its available charge and that it can support another R/C mission. In my experience, the unloaded voltage of a 4-cell pack should recover to greater than 5V (6.25V for a 5-cell pack, 10V for 8 cells) when allowed to rest for 5-10 minutes after a period of use. If it passes this test, then when a current load is placed on the pack, the voltage should only drop a few tenths of a volt and then stabilize within about 10 seconds. If the voltage continues to drop, the batteries should be recharged before further use.

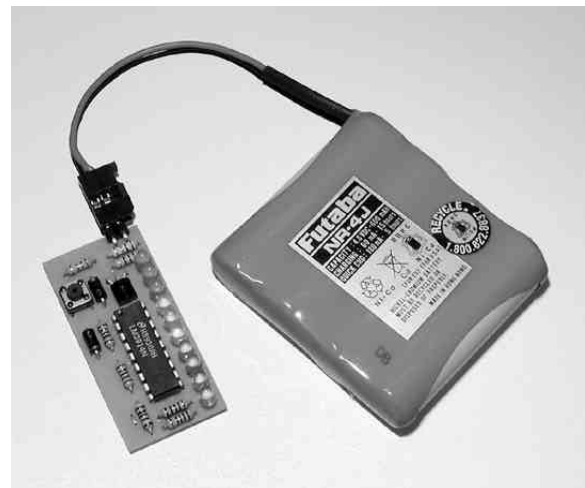

Fig. 4 Photograph of HOTCHEK battery meter connected to the 600mAh 4-cell NiCd battery pack used for the measurements in this article.

The HOTCHEK ESV

The HOTCHEK is an expanded scale voltmeter (ESV). That means that, rather than reading voltages between a maximum voltage and zero,

it expands a specific voltage range of interest over the full display scale. Based on the discussion and the discharge tests in the previous section (Fig's 2 and 3), I have chosen a display range of 4.7 to 5.2V for a 4-cell NiCd battery pack. Other voltage ranges can be selected by the proper choice of three resistor components. The expanded range is displayed on a series of 10 light emitting diodes (LED's). These can be configured to light one at a time making it a moving dot display or they can be configured to light in a continuous left to right bar graph display. The dot display mode should be used for onboard applications where it is useful to minimize the current draw (~10mA per LED).

By pressing the HOTCHEK's button, a current load of about 300mA is placed across the battery pack in order to read the loaded battery voltage. When the bar display mode is used to display the voltage of a fully charged battery pack, the 100mA used to light the 10 LED's adds to the 300mA load, increasing the current to about 400mA.

The HOTCHEK is based on the LM3914 integrated circuit (IC). This IC is specifically designed as a voltage display driver. A complete description of the LM3914 can be found at National Semiconductor's internet web site.¹ The use of the LM3914 for expanded scale voltage measurement in R/C is not a new idea. The IC has been used in a number of hobby designs as well as several commercial products for R/C. However, the thing that distinguishes the HOTCHEK design is the built-in transistor-based load circuitry that allows the battery voltage with and without a current load to be quickly and easily compared. Also, a noteworthy feature of the HOTCHEK is the ability to easily tailor its voltage measurement range to a wide variety of battery applications.

Theory of operation

Fig. 6 shows an electrical schematic of the HOTCHEK design. Diodes D11 and D12 are used to provide reverse polarity protection; that is, to prevent damage to the IC if the HOTCHEK is accidentally hooked up with input leads reversed. The only effect of the diodes in normal operation is to cause a 0.7V drop in the voltage reaching the circuit.

The push button SW1 is used to engage the current load. In order to keep the HOTCHEK design very compact, the small push button that is used is rated for a current of only 20mA, much less than the 300mA test current needed. For this reason, a NPN transistor Q1 is used to amplify the current through SW1 and resistor R1. The main current is then drawn through the 10 resistor R2. This brings us to another aspect of the HOTCHEK's design. A current of 300mA through a 10 resistor results in a power of almost 1 watt. The small resistor used in the HOTCHEK is only rated for a continuous power of 1/4W, four times less than the power dissipated in the 10 resistor! Big problem? Not at all, but this is the source of the battery checking circuit's name: HOTCHEK. The 10 load resistor becomes quite hot at the 1W power level. However, it is only necessary to apply the load for about 10-20 seconds. The resistor gets hot but easily survives this momentary abuse. The advantage of this design is that a resistor sized to sustain the continuous required power would be almost the size of the entire HOTCHEK circuit! It is important to note that the long discharge cycles presented in Fig's 2 and 3 were not collected using the HOTCHEK since its current load should not be engaged continuously for more than 20 seconds at a time.

The maximum supply voltage that can be used with the LM3914 IC is 20V and the maximum voltage that can be measured and displayed is 1.5V less than the supply voltage. Since it is necessary to power the HOTCHEK circuit with the same voltage source that is to be measured, resistors R3 and R4 form a voltage divider that halves the supply voltage delivered to the measurement pin #5. The upper and lower voltage limits of the expanded scale are also divided by 2, making the entire scaling process undetectable by the user. The lower limit of the voltage display scale is applied to pin #4 and the upper voltage to pin #6 of the IC. The IC has a built in voltage reference that is used to set the range of the expanded voltage scale. The output of the reference voltage pin #7 is automatically controlled so that the adjust pin #8 is 1.25V less than the reference voltage. The HOTCHEK uses a voltage dividing ladder made up of R6, R7, and R8 to set the upper and lower voltage display limits based on this reference. Recognizing that there is about a 0.1mA leakage current from the voltage adjust pin #8 and taking

into account the 0.7V drop across D12, a set of simple formulas can be used to set the values for these three resistors. Defining V_H to be the upper display voltage, V_L to be the lower display voltage, and $V = V_H - V_L$ the total display range, then

$$R_6 = 600 \times V \quad (1)$$

$$R_7 = R_6 \times (2.5 \div V - 1) \quad (2)$$

$$R_8 = (V_H - 3.2) \div (V \div R_6 + 0.0002) \quad (3)$$

The sum of these three resistances also determines the brightness of the LED's. The current through each LED is approximately 10 times the current drawn out of the reference pin #7. For an LED current of 10mA, the current from reference pin should be about 1mA and this consideration is built into the three equations.

An important consideration for adjusting the voltage measurement range is that, because of the specific way that I have designed the voltage divider ladder, the maximum voltage range that can be displayed is 2.5V. An attempt to set V to greater than 2.5 will result in a negative resistance for R_7 which of course cannot be achieved.

I chose to use 1% metal film resistors for R3 through R8 so that the voltage display range can be set with reasonable accuracy without requiring an adjustable component such as a potentiometer. The value of the 1% resistors come in approximately 2-3% increments allowing the resistances to be set very near the calculated values. Also, metal film resistors have a much better temperature stability than standard 5% carbon composite resistors.

Setting the voltage display range

To illustrate the process of setting the resistance values, let's walk through the setup of the 4.7 to 5.2V expanded scale range for a 4-cell NiCd battery pack. First, using a value of 0.5 (5.2 minus 4.7) for V in equation (1) yields a value for R_6 of 300 . The closest value for a 1% resistor to 300 is 301 . Using 301 for R_6 and 0.5 for V in equation (2), a value of 1204 is calculated for R_7 . R_7 is therefore set to 1.21k , the closest available value for a 1%

resistor. Now, plugging in 301 for R_6 , 0.5 for V , and 5.2 for V_H into equation (2), a value of 1075 is calculated for R_8 . The closest available resistor to 1075 is 1.07k . As shown in Table 1, the resistances for components R6, R7, and R8 are therefore 301, 1.21k, and 1.07k , respectively.

The 4.7 to 5.2V display range chosen for a 4-cell NiCd pack can be scaled up by 25% to 5.9 to 6.5V for a 5-cell pack. Using equations (1) - (3), values of 357, 1.13k, and 1.74k are then determined for R6, R7, and R8, respectively. Values of 604, 909, and 3.92k set the range to 9.4 to 10.4V for an 8-cell NiCd receiver pack. These alternate values are also shown in the parts list of Table 1.

An easy to use Excel spreadsheet can be downloaded from the internet.² The user is required only to enter the desired voltage display range and R_6 , R_7 , and R_8 as well as the voltage load resistor R_2 are automatically calculated. Keep in mind that you may also want to customize the color arrangement of the display LEDs to fit your chosen display range.

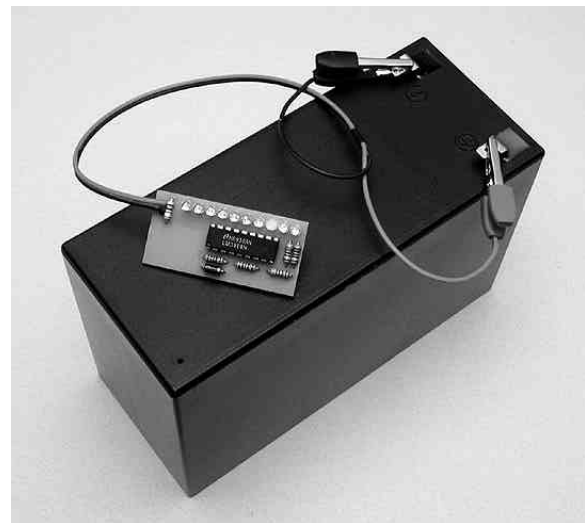

Fig. 5 The 12V version of the HOTCHEK circuit is a great companion to a field box lead-acid battery. Note that the components for the test load have been omitted (see text).

12V lead-acid batteries

The voltage measurement range of the HOTCHEK can also be set up for 12V lead-acid

batteries such as those used in field boxes to power portable battery chargers and electric engine starters. It can be used for both standard lead-acid batteries with liquid electrolyte as well as sealed gel-cell batteries. According to Red Scholefield's Battery Clinic,³ the charge capacity of a lead-acid battery can be determined by the measured voltage without a current load. A fully charged battery has a voltage of 13V or more and a fully discharged battery has a voltage of around 12V. Based on this, a suggested set up for the HOTCHEK is a measurement range from 12 to 13V. Resistor values of 604, 909, and 5.23k for R6, R7, and R8, respectively, provide this voltage range. Unlike for NiCd batteries, the number of LEDs that are lit can be directly interpreted as the fraction of charge left in the 12V battery. A 300mA load is not meaningful for testing high capacity lead-acid batteries which will show little output voltage reduction for this current. I suggest that you leave out the components used for the current load: R1, R2, Q1, D11, and SW1. If you choose not to do this, then the load resistor R2 should be increased from 1/4 watt 10 to 1/2 watt 39 in order to keep a 300mA test current at the increased 12-13V test voltage.

Construction

Table 1 is a complete parts list with the Digi-Key Electronics⁴ catalog numbers. Fig. 7 is a 2X enlarged pattern for the printed circuit board. The best way, I believe, of making this board is with a product called "Press-n-Peel."⁵ It is a blue plastic film that can be run through a conventional photocopy machine or printed onto directly with a laser writer computer printer. Following the instructions supplied with the film, the image in Fig. 7 should be copied onto the dull side with 50% reduction. It is then ironed onto a copper clad board (Radio Shack 276-1499) using a household or your airplane film sealing iron. When experimenting with the best temperature, I find it useful to securely tape the film to the board along one edge. I can then carefully peel back a small portion to test the adhesion of the pattern to the board. If the transfer is incomplete, the film is let back down and additional pressure at a higher temperature used.

After successful image transfer, the board is etched in a solution of ferric chloride (Radio

Shack 276-1535) for 30-60 minutes or until all of the unwanted copper is gone. Note that the blank board is two-sided so the copper will be completely removed from the back side. This board is large enough to simultaneously make up to 12 HOTCHEK printed circuit boards. After etching, the mounting holes should be drilled with a #65 drill bit. This is easily accomplished since the copper surrounding each hole location accurately guides the drilling. Those modelers interested in building a circuit but who do not want to manufacture a PC board may contact the author. Alternatively, a complete unassembled kit can be obtained.⁶

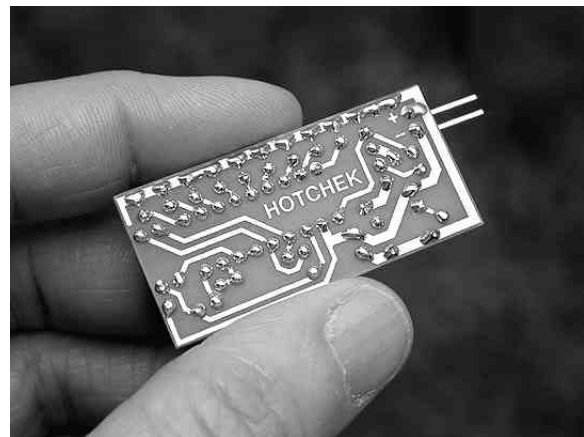

Fig. 9 Photograph of the assembled HOTCHEK from the trace side of the printed circuit board.

Fig. 8 shows a diagram of the installation of the components onto the board. They should be inserted from the side opposite from the copper circuit pattern. Table 1 is a list of the components with their required values. Special attention should be given to IC1, Q1, and D1-D12 since the direction they are installed is very important. The LEDs often have a small flat on one side that should be oriented as shown in Fig. 8. If the LED's don't have the flat, then the positive lead (upper lead in the figure) can be identified by the fact that it is longer than the negative lead. Diodes D11 and D12 have a stripe identifying one of the leads. I have found that LEDs with clear lenses are most visible in sunlight conditions. However, note that it is not possible to distinguish between the three colors until they are installed in the circuit and operating. For this reason, take care not to lose track of which color LED is which. The 1%

metal film resistors are blue with five color bands. The last band is always brown, indicating 1%, and is spaced a bit farther from the other four bands to identify it. I find that the color of the bands is sometimes difficult to make out against the blue background so good lighting and patience is suggested here. I often resort to confirming the resistances with a digital multimeter when faced with trying to distinguish between red, brown, and orange bands. Optional jumper J1 can be made from a short piece of trimmed resistor lead. If J1 is left out, then the display will be a single moving dot display. If J1 is installed, then the bar mode is activated.

Carefully solder the installed components to the copper circuit pattern, taking care to avoid solder bridges across gaps between the traces. It is *extremely important* to use a good quality resin core electronics-grade solder and to brighten the copper traces with fine steel wool or a scotch-brite pad before starting. Advice and/or instruction from a fellow modeler with circuit assembly experience could be useful here. Fig. 9 shows the completed soldering job on the trace side of the board. The excess resin left from soldering can be easily removed with a solvent such as lacquer thinner and an epoxy brush with the bristles cut back to 1/4". A 90° 2-pin header can be used for the input voltage as shown in Fig. 1. Alternatively for onboard applications, a servo wiring harness can be soldered into the board so that the HOTCHEK can be plugged directly into the receiver. Table 2 summarizes the wire color codes typically used for some common radio systems. Using Fig. 8, carefully attach the leads according to this chart. Users of older Airtronics equipment should be cautioned that the V+ and V- wires are reversed in the servo harness from those for Futaba, JR, and RCD radio systems. Since the Airtronics harness has two wires of the same color (black), carefully note which one is denoted as the center wire in Table 2. For onboard installations, you may want to omit the current loading circuitry (R1, R2, Q1, D11, and SW1) to prevent possible binding against the test button and accidental engagement of the test load during operation of the R/C vehicle. As previously discussed, the loading section of the circuit also has little utility for 12V lead-acid batteries and can be omitted.

Using the HOTCHEK

The HOTCHEK can be used either as a very compact handheld ESV meter or as a voltage monitor mounted in the R/C vehicle. Remove jumper J1 to minimize current draw for onboard installations. It is often very useful to watch the onboard voltage display while the servos and other onboard equipment is exercised before a flight. For the "pocket ESV" approach, I like to insert the HOTCHEK into a short length of 1" clear heat shrinkable tubing in order to protect the circuit. Care should be exercised not to overheat the components when shrinking. After shrinking, a small hole can be cut through the covering over the test button using the sharpened end of a 3/16" diameter brass tube. The two prongs from the HOTCHEK's 90° header can be easily inserted into the external charging jack on the R/C vehicle to check the battery voltage as shown in Fig. 10.



Fig. 10 Battery check on the author's Pica Cessna 182 using the external charge jack. Note the protective clear heat shrinking around the HOTCHEK (see text).

As is shown in Fig. 3, the open circuit voltage (no load) of a 4-cell NiCd receiver pack should be at least 5V (6.25 for 5-cell). In other words, one of the four green LEDs or at least the rightmost yellow LED should be lit. When the 300mA load is engaged, the voltage should drop by 1 to 2 LEDs and then stabilize within about 10 seconds. It is important to note that there is the possibility of voltage losses through the receiver battery wiring harness and connectors onboard the R/C vehicle. These losses could cause another 0.1V or more drop when the load is engaged. If the voltage drop due to the

battery wiring harness is excessive with a freshly charged pack, this may indicate that either shorter leads to the battery or heavier gauge wire is required. In this case the HOTCHEK is helping to identify a separate problem from a simple case of a discharged battery pack.

When using the HOTCHEK, you should recognize that it is not unusual for the display range to be up to 1 LED in error in one direction or the other. Since there are no adjustable components, small variations in component values can cause this small offset. The major source of possible errors is the result of variations in the leakage current from the reference adjust pin #8 on the LM3914. If you would like to fine tune the display range, adjust resistor R8 up to the next available value to raise the display range or down to the next available value to make a small adjustment downward. However, if you choose not to do this, a small offset should not cause problems in using the HOTCHEK as a general battery diagnostic tool for comparing the unloaded and loaded battery voltage. In practice, I have found the component values shown in Table 2 produce acceptably accurate results.

Final words of advice

Does it sound like the HOTCHEK is the ultimate answer to all of your battery checking needs? If so, you may have missed something and should go back and carefully read this article again. The use and maintenance of rechargeable batteries is a challenging task and there is no single magic bullet to prevent battery related R/C failures. The most important thing that you can do is to learn the behavior of your specific battery packs and carefully monitor them before, during, and after use. The HOTCHEK can be a very valuable tool for helping you to do this. I also strongly suggest that the condition of your packs be checked on a regular basis with a good quality commercial battery cycler. Remember, your safety as well as the safety of others depends on the health of the batteries that power your R/C equipment.

The author

Brent Dane has been an AMA member and an R/C model pilot since 1990. He is a member of both the Livermore Flying Electrons and the East Bay Radio Controllers, two AMA chartered clubs which have flying fields near Livermore, CA. Brent is a physicist in the laser program at Lawrence Livermore National Laboratory. For answers to questions or for additional information about the HOTCHEK, Brent can be contacted on the internet at e-mail address cbdane@pacbell.net or visit his web site at <http://www.cliftech.com/>.

End notes

1. <http://www.national.com/pf/LM/LM3914.html> for a complete description of the LM3914 dot/bar driver IC and to download the manufacturer's data sheet.
2. <http://www.cliftech.com/> for the Excel spreadsheet resistance calculator to adjust the voltage display range for the HOTCHEK.
3. <http://gnv.fdt.net/~redscho/> for a discussion of lead-acid batteries as well as other useful information on rechargeable batteries at Red Scholefield's Battery Clinic.
4. <http://www.digikey.com>, Digi-Key Electronics, 1-800-344-4539.
5. Press-n-Peel is manufactured and distributed by Techniks, <http://www.techniks.com>.
6. To receive an etched printed circuit board, send a check or money order for \$10.00 per board to Brent Dane, 678 Crane Ave, Livermore, CA 94550. A complete unassembled kit can be obtained for \$20.00 (includes postage and handling). The kit includes all of the resistors required for a 4, 5, or 8-cell NiCd pack or for a lead-acid field box battery. For more information, contact cbdane@pacbell.net.

Table 1

Part	Description	Color code	Digi-Key part#
IC1	LM3914N dot/bar graph display driver		LM3914N-ND
Q1*	PN2222 30V, 500mA,NPN transistor		PN2222-ND
D1	Red 3mm clear LED		160-1138-ND
D2	Red 3mm clear LED		160-1138-ND
D3	Red 3mm clear LED		160-1138-ND
D4	Yellow 3mm clear LED		160-1147-ND
D5	Yellow 3mm clear LED		160-1147-ND
D6	Yellow 3mm clear LED		160-1147-ND
D7	Green 3mm clear LED		160-1144-ND
D8	Green 3mm clear LED		160-1144-ND
D9	Green 3mm clear LED		160-1144-ND
D10	Green 3mm clear LED		160-1144-ND
D11*	IN4001 50V, 1A rectifier		1N4001DICT-ND
D12	IN4001 50V, 1A rectifier		1N4001DICT-ND
SW1*	Miniature push button		P8009S-ND
R1*	1k 5% 1/4W resistor	brown, black, red, gold	1.0KQBK-ND
R3	2.21k 1% 1/4W resistor	red, red, brown, brown, brown	2.21KXBK-ND
R4	2.21k 1% 1/4W resistor	red, red, brown, brown, brown	2.21KXBK-ND
R5	10k 5% 1/4W resistor	brown, black, orange, gold	10KQBK-ND
	2-pin 90° gold-plated header		S1311-2-ND
4-cell NiCd pack, 4.7–5.2V display range			
R2	9.1 5% 1/4W resistor	white, brown, gold, gold	9.1QBK-ND
R6	301 1% 1/4W resistor	orange, black, brown, black, brown	301XBK-ND
R7	1.21k 1% 1/4W resistor	brown, red, brown, brown, brown	1.21KXBK-ND
R8	1.07k 1% 1/4W resistor	brown, black, violet, brown, brown	1.07KXBK-ND
5-cell NiCd pack, 5.9–6.5V display range			
R2	16 5% 1/4W resistor	brown, blue, black, gold	16QBK-ND
R6	357 1% 1/4W resistor	orange, green, violet, black, brown	357XBK-ND
R7	1.13k 1% 1/4W resistor	brown, brown, orange, brown, brown	1.13KXBK-ND
R8	1.74k 1% 1/4W resistor	brown, violet, yellow, brown, brown	1.74KXBK-ND
8-cell NiCd pack, 9.4–10.4V display range			
R2	33 5% 1/2W resistor	orange, orange, black, gold	33H-ND
R6	604 1% 1/4W resistor	blue, black, yellow, black, brown	604XBK-ND
R7	909 1% 1/4W resistor	white, black, white, black, brown	909XBK-ND
R8	3.92k 1% 1/4W resistor	orange, white, red, brown, brown	3.92KXBK-ND
12V lead-acid battery, 12-13V display range			
R2*	43 5% 1/2W resistor	yellow, orange, black, gold	43H-ND
R6	604 1% 1/4W resistor	blue, black, yellow, black, brown	604XBK-ND
R7	909 1% 1/4W resistor	white, black, white, black, brown	909XBK-ND
R8	5.23k 1% 1/4W resistor	green, red, orange, brown, brown	5.23KXBK-ND

* The load resistor R2 as well as R1, Q1, D11, and SW1 should generally be left off for 12V lead-acid batteries since the charge state is well determined by the open circuit voltage (see discussion in text).

Table 2

Manufacturer	Negative voltage (-)	Positive voltage (+)	Signal (not used)
Ace R/C	black	red (center wire)	orange, blue, or white
Airtronics / Sanwa	black (center wire)	black with red stripe	black
Airtronics Z	black	red (center wire)	blue
Cannon	black	red (center wire)	orange, blue, yellow, other
Futaba	black	red (center wire)	white
Hitec / RCD	black	red (center wire)	yellow
Hobby Shack	black	red (center wire)	white
JR	brown	red (center wire)	orange
KO Propo	black	red (center wire)	blue
Kraft	black	red (center wire)	orange
Kyosho / Pulsar	black	red (center wire)	yellow
Tower Hobbies	black	red (center wire)	white

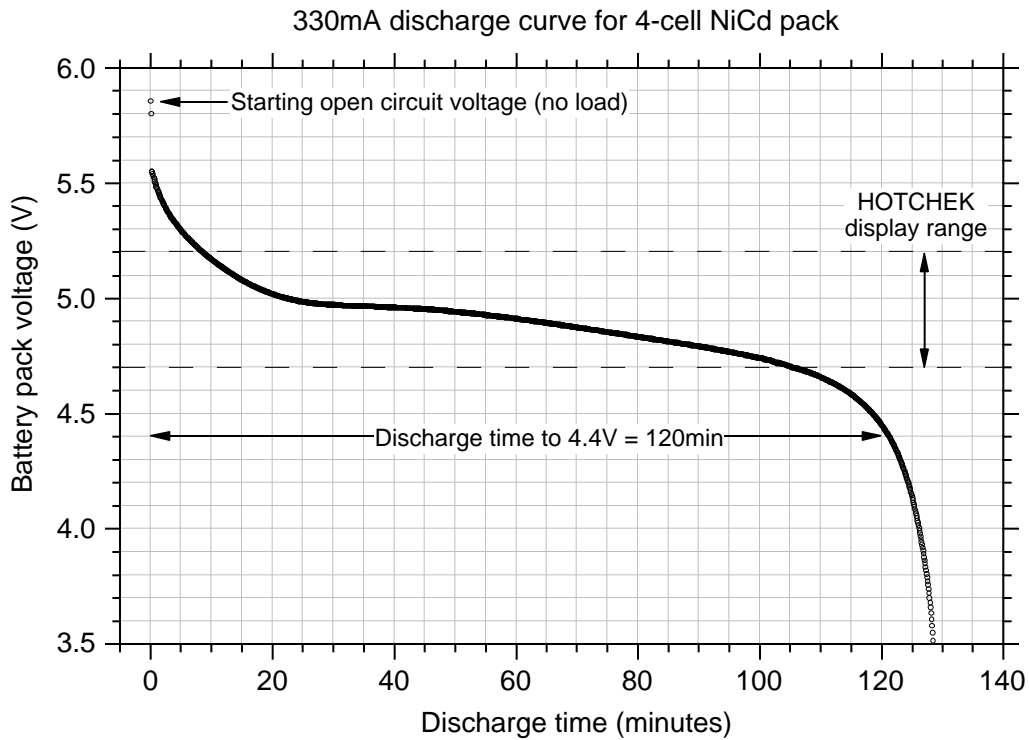

Figure 2 – Continuous 330mA discharge curve for a 600mAh 4-cell NiCd battery pack.

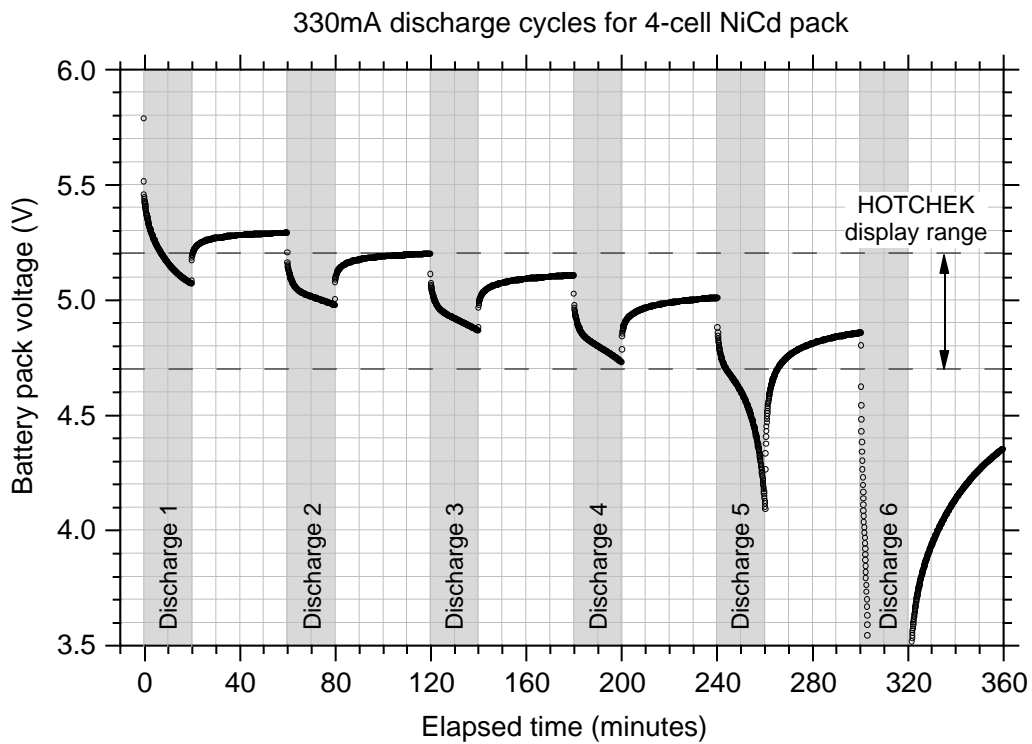

Figure 3 – 20 minute 330mA discharge cycles (grey bars) spaced by 40 minute battery recovery periods. The same 600mAh battery pack from Figure 2 was used.

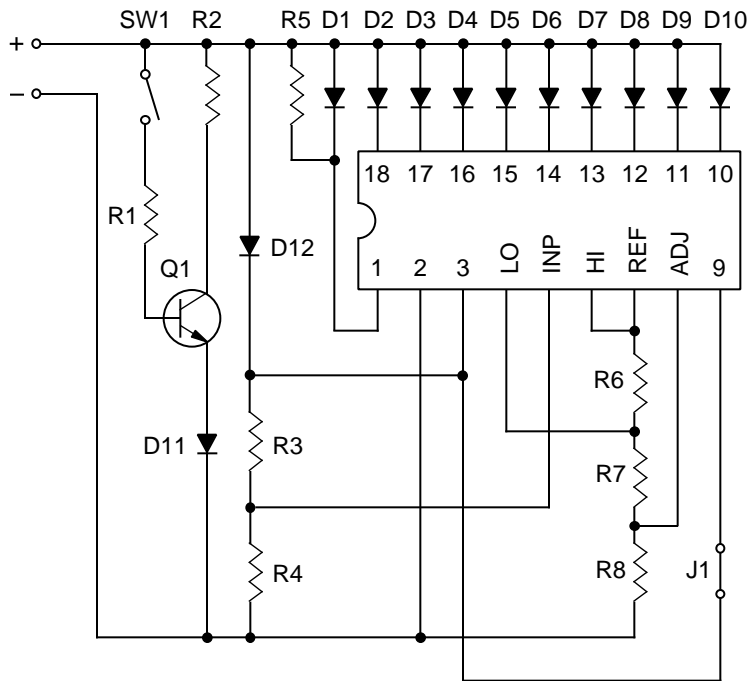

Figure 6 – Electronic schematic of the HOTCHEK circuit.

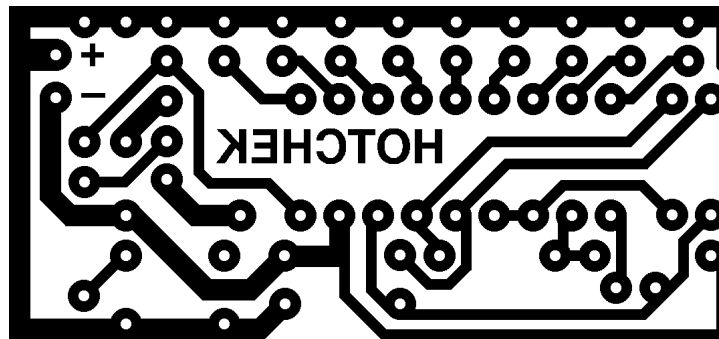

Figure 7 – 2X enlarged printed circuit board pattern for the HOTCHEK circuit.

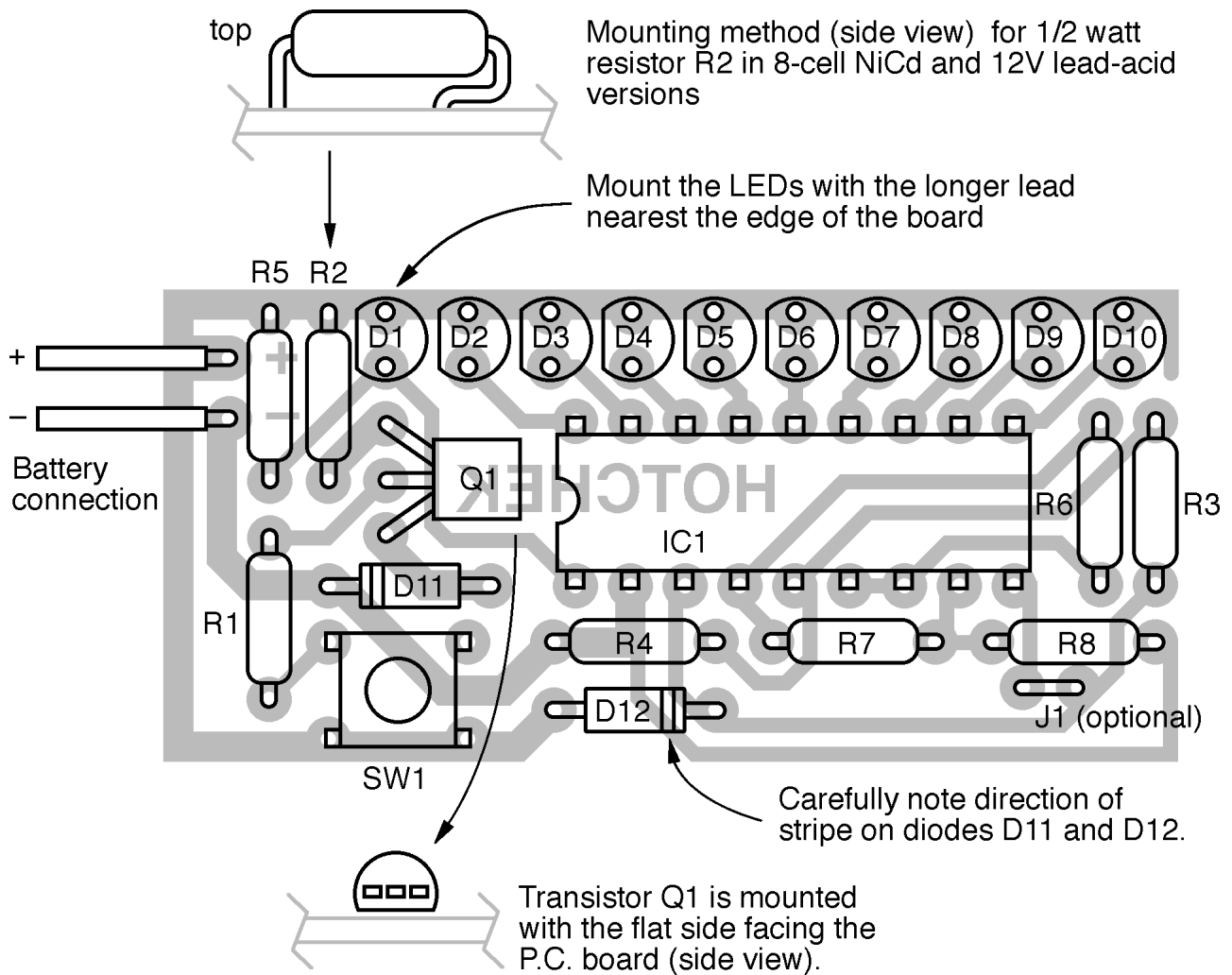

Figure 8 – Component installation for the HOTCHEK circuit.